

**IMO PRECISION CONTROLS**  
**PROCESS CONTROLLERS**  
**DIGITAL INDICATING CONTROLLER**

# **TP20A**

## **MANUAL**

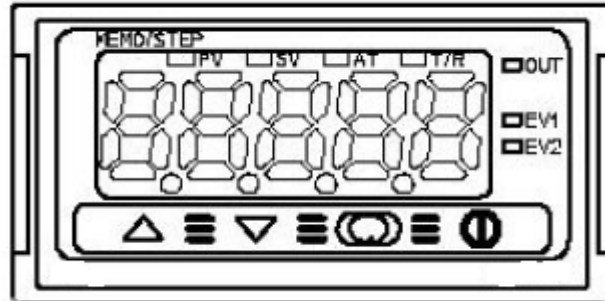

# Preface

Thank you for purchasing our Micro-computer based Digital Indicating Controller TP20A.

This manual contains instructions for the mounting, functions, operations and notes when operating the TP20A. For model confirmation and unit specifications, please read this manual carefully before starting operation.

**To prevent accidents arising from the misuse of this controller, please ensure the operator receives this manual.**

## Notes

- This instrument should be used in accordance with the specifications described in the manual. If it is not used according to the specifications, it may malfunction or cause fire.
- Be sure to follow the warnings, cautions and notices. If it is not, serious injury or accidents may occur.
- The contents of this instruction manual are subject to change without notice.
- Care has been taken to assure that the contents of this instruction manual are correct, but if there are any doubts, mistakes or questions, please inform our sales department.
- This instrument is designed to be installed in a control panel. If it is not, measures must be taken to ensure that the operator cannot touch power terminals or other high voltage sections.
- Any unauthorized transfer or copying of this document, in part or in whole, is prohibited.
- IMO Precision Controls LTD. is not liable for any damage or secondary damage(s) incurred as a result of using this product, including any indirect damage.

## Safety precautions

**(Be sure to read these precautions before using our products.)**

The safety precautions are classified into categories: "Warning" and "Caution".

Depending on circumstances, procedures indicated by  Caution may be linked to serious results, so be sure to follow the directions for usage.

### **Warning**

Procedures which may lead to dangerous conditions and cause death or serious injury, if not carried out properly.

### **Caution**

Procedures which may lead to dangerous conditions and cause superficial to medium injury or physical damage or may degrade or damage the product, if not carried out properly.

## **SAFETY PRECAUTIONS**

- To ensure safe and correct use, thoroughly read and understand this manual before using this instrument.
- This instrument is intended to be used for industrial machinery, machine tools and measuring equipment. Verify correct usage after consulting purpose of use with our agency or main office.  
(Never use this instrument for medical purposes with which human lives are involved.)
- External protection devices such as protection equipment against excessive temperature rise, etc. must be installed, as malfunction of this product could result in serious damage to the system or injury to personnel. Also proper periodic maintenance is required.
- This instrument must be used under the conditions and environment described in this manual. IMO Precision Controls Ltd. does not accept liability for any injury, loss of life or damage occurring due to the instrument being used under conditions not otherwise stated in this manual.

### **Caution with respect to Export Trade Control Ordinance**

To avoid this instrument from being used as a component in, or as being utilized in the manufacture of weapons of mass destruction (i.e. military applications, military equipment, etc.), please investigate the end users and the final use of this instrument.

In the case of resale, ensure that this instrument is not illegally exported.

## 1. Installation precautions



### Caution

This instrument is intended to be used under the following environmental conditions (IEC61010-1): Overvoltage category II, Pollution degree 2

Ensure the mounting location corresponds to the following conditions:

- A minimum of dust, and an absence of corrosive gases
- No flammable, explosive gases
- No mechanical vibrations or shocks
- No exposure to direct sunlight, an ambient temperature of 0 to 50°C (32 to 122°F) that does not change rapidly
- An ambient non-condensing humidity of 35 to 85%RH
- No large capacity electromagnetic switches or cables through which large current is flowing
- No water, oil or chemicals or where the vapors of these substances can come into direct contact with the unit

Note: Do not install this instrument near flammable material even though the case of this instrument is made of flame-resistant resin.

Avoid setting this instrument directly on flammable material.

## 2. Wiring precautions



### Caution

- Use the solderless terminal with an insulation sleeve in which the M3 screw fits when wiring the TP20A Series.
- Tighten the terminal screw within the specified torque. If excessive force is applied to the screw when tightening, the terminal screw or case may be damaged.
- Do not apply a commercial power source to the sensor which is connected to the input terminal nor allow the power source to come into contact with the sensor.
- This controller does not have built-in power switch, circuit breaker or fuse. It is necessary to install them near the controller.  
(Recommended fuse: Time-lag fuse, rated voltage 250V AC, rated current 2A)
- For a 24V AC/DC power source, do not confuse polarity when using direct current (DC).

## 3. Running and maintenance precautions



### Caution

- It is recommended that the PID auto-tuning be performed on the trial run.
- Do not touch live terminals. This may cause electric shock or problems in operation.
- Turn the power supply to the instrument OFF before retightening the terminal and cleaning.
- Working or touching the terminal with the power switched ON may result in severe injury or death due to Electric Shock.
- Use a soft, dry cloth when cleaning the instrument.  
(Alcohol based substances may deface or tarnish the unit)
- As the display section is vulnerable, do not strike or scratch it with a hard object.

# --- CONTENTS ---

<b>1. Model</b>	
1.1 Model -----	5
1.2 How to read the model label -----	5
<b>2. Name and functions of the sections</b> -----	5
<b>3. Mounting to the control panel</b>	
3.1 Site selection -----	6
3.2 External dimensions -----	6
3.3 Panel cutout -----	6
3.4 Mounting -----	6
<b>4. Wiring</b> -----	7
<b>5. Setup</b> -----	8
<b>6. Settings</b>	
6.1 Main setting mode -----	14
6.2 Sub setting mode -----	16
6.3 Auxiliary function setting mode 1 -----	17
<b>7. Running</b>	
7.1 Start running -----	18
7.2 MV (Control output manipulated variable) indication -----	19
7.3 Control output OFF function -----	19
7.4 Auto-tuning (AT) Perform/Cancel -----	19
<b>8. Operation flowchart</b> -----	20
<b>9. PID auto-tuning</b> -----	22
<b>10. Action explanation</b>	
10.1 OUT1 action -----	23
10.2 OUT1 ON/OFF action -----	23
10.3 A1, A2 action -----	24
10.4 OUT2 (Heating/Cooling control) action (When DR option is added) ---	24
10.5 OUT2 (Heating/Cooling control) action (When setting dead band) (When DR option is added) -----	25
10.6 OUT2 (Heating/Cooling control) action (When setting overlap band) (When DR option is added) -----	25
10.7 Timer action -----	25
<b>11. Specifications</b>	
11.1 Standard specifications -----	26
11.2 Optional specifications -----	29
<b>12. Troubleshooting</b>	
12.1 Indication -----	29
12.2 Key operation -----	30
12.3 Control -----	31
<b>13. Character table</b> -----	31

# 1. Model

## 1.1 Model

TP 20	A	-□/□, □ □ □ □	Series name: TP20A (W48 x H24 x D98.5mm)
A1	A		Alarm type can be selected by keypad. *1
Control output, Heating output (OUT1)	R		Relay contact: 1a
	S		Non-contact voltage (for SSR drive): 12 <sup>+2</sup> <sub>0</sub> V DC
	A		DC current: 4 to 20mA DC
Input	M		Multi-range *2
Supply voltage			100 to 240V AC *3
	1		24V AC/DC *3
Option	DR		Heating/Cooling control, Cooling output (OUT2)
			Relay contact output
	C5		Serial communication (RS-485)
	BK		Color: Black
	TC		Terminal cover

\*1: Alarm types (9 types and No alarm action), Timer function and Pattern end output can be selected by keypad.

\*2: Thermocouple, RTD, DC current and DC voltage can be selected by keypad.

For DC current input, **50Ω shunt resistor** must be connected between input terminals.

\*3: For the power supply voltage, **100 to 240V AC is standard**. However, when ordering 24V AC/DC, enter "1" after the input code.

## 1.2 How to read the model label

Model labels are attached to the case and the inner assembly.

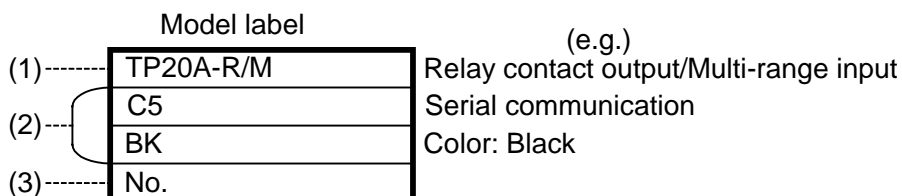

(1): Model

(2): Option, supply voltage ("1" is entered only for 24V AC/DC)

(3): Serial number (Only on the inner assembly)

## 2. Name and functions of the sections

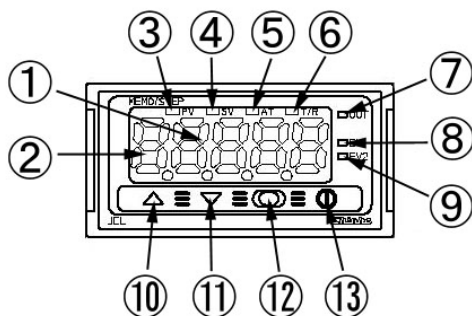

① **PV/SV display (red)**: Indicates the PV (process variable) and SV (Main set value). During setting mode, characters and set value of the setting item are indicated alternately.

② **MEMO/STEP display (green)**: Indicates memory number during fixed value control. Indicates step number during program control.

③ **PV indicator (red)**: Lights when PV (process variable) is indicated.

④ **SV indicator (green)**: Lights when SV (main set value) is indicated.

⑤ **AT indicator (yellow)**: Flashes during AT (auto-tuning).

⑥ **T/R indicator (yellow)**: Flashes during serial communication.

(Lit while sending data. Unlit while receiving data)

⑦ **OUT indicator (green)**: Lights when is OUT1 [Control output or Heating output (DR option)] is ON.

(For DC current output type, it flashes corresponding to the manipulated variable in 0.25 second cycles)

⑧ **EV1 indicator (red)**: Lights when Event output 1 or OUT2 [Cooling output (DR option)] is ON.

⑨ **EV2 indicator (red)**: Lights when Event output 2 is ON.

⑩ **Increase key (△)**: Increases the numeric value.

⑪ **Decrease key (▽)**: Decreases the numeric value.

⑫ **Mode key (○)**: Selects the setting mode or registers the set value.

By pressing the Mode key, the set (selected) value can be registered.

⑬ **OUT/OFF key (⓪)**: The control output OUT/OFF or program control RUN/STOP can be switched. TP

# 3. Mounting to the control panel

## 3.1 Site selection

This instrument is intended to be used under the following environmental conditions (IEC61010-1): **Overtoltage category II, Pollution degree 2**

Ensure the mounting location corresponds to the following conditions:

- A minimum of dust, and an absence of corrosive gases
- No flammable, explosive gases
- No mechanical vibrations or shocks
- No exposure to direct sunlight, an ambient temperature of 0 to 50°C (32 to 122°F) that does not change rapidly
- An ambient non-condensing humidity of 35 to 85%RH
- No large capacity electromagnetic switches or cables through which large current is flowing
- No water, oil or chemicals or where the vapors of these substances can come into direct contact with the controller

## 3.2 External dimensions (Unit: mm)

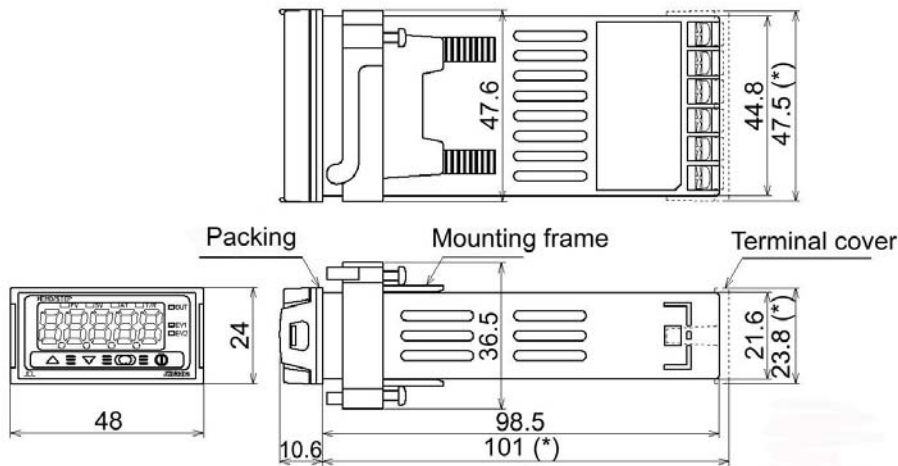

(Fig. 3.2-1)

(\*): When terminal cover is added.

## 3.3 Panel cutout (Unit: mm)

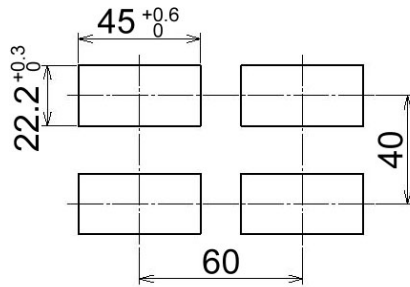

(Fig. 3.3-1)

## 3.4 Mounting

Mount the controller vertically to the flat, rigid panel to ensure it adheres to the Dust-proof/Drip-proof specification (IP66).

Mountable panel thickness: Within 1 to 10mm

(1) Insert the controller from the front side of the panel. (Fig. 3.4-1)

(2) Insert the mounting frame until 2 tips of the frame touch the panel. (Fig. 3.4-2)

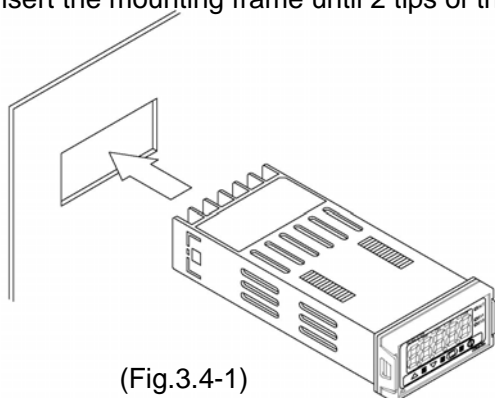

(Fig.3.4-1)

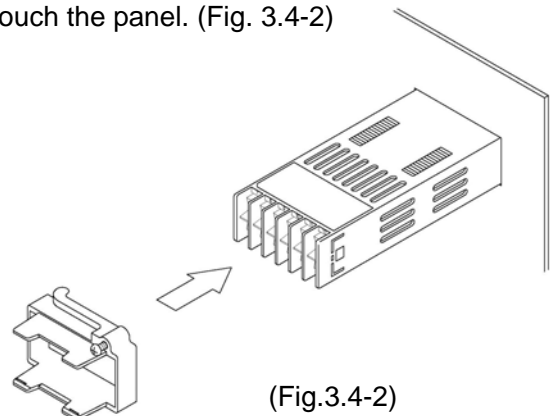

(Fig.3.4-2)

# 4. Wiring

## Warning

Turn the power supply to the instrument off before wiring.  
Working or touching the terminal with the power switched on may result in severe injury or death due to Electric Shock.

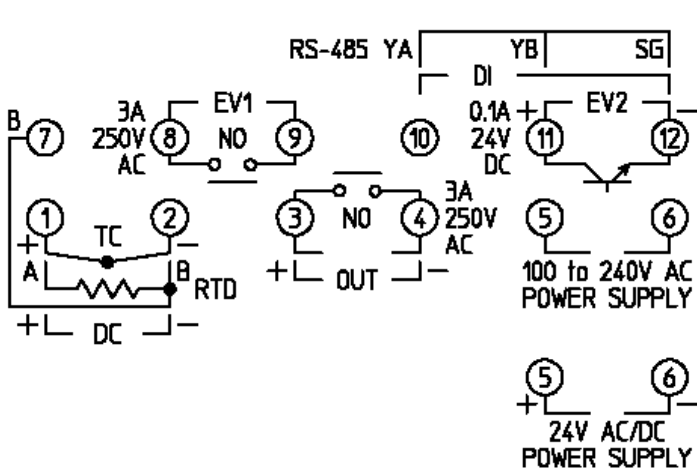

(Fig. 4-1)

- POWER SUPPLY: Power terminals
- EV1 : Event output 1 or OUT2 [Cooling output (DR option)] terminals
- EV2 : Event output 2 terminals
- OUT : OUT1 [Control output or Heating output (DR option)] terminals
- DI : DI (Digital input) terminals  
Three DI functions: SV1/SV2 external selection function, OUT/OFF(RUN/STOP) external selection and Timer function
- RS-485: Serial communication (C5) terminals
- TC : Thermocouple input terminals
- RTD : RTD input terminals
- DC : DC current, DC voltage input terminals  
For DC current input type, **connect 50Ω shunt resistor** (sold separately) between input terminals.

## Caution

- Use a thermocouple and compensating lead wire corresponding to the sensor input specification of this controller.
- Use the 3-wire RTD corresponding to the input specification of this controller.
- This controller does not have built-in power switch, circuit breaker or fuse. Therefore, it is necessary to install them in the circuit near the external controller.  
(Recommended fuse: Time-lag fuse, rated voltage 250V AC, rated current 2A)
- **For a 24V AC/DC power source, do not confuse polarity when using direct current (DC).**
- When using a relay contact output type, externally use a relay according to the capacity of the load to protect the built-in relay contact.
- When wiring, keep input wires (thermocouple, RTD, etc.) away from AC sources or load wires to avoid external interference.
- Do not apply a commercial power source to the sensor connected to the input terminal nor allow the power source to come into contact with the sensor.

### Lead wire solderless terminal

Use a solderless terminal with an insulation sleeve in which the M3 screw fits as shown below. The torque is approximately 0.6N•m to 1.0N•m.

Solderless terminal	Manufacturer	Model	Tightening torque
Y type	Nichifu Terminal Industries CO., LTD.	1.25Y-3	0.6N•m Max. 1.0N•m
	Japan Solderless Terminal MFG CO., LTD.	VD1.25-B3A	
Round type	Nichifu Terminal Industries CO., LTD.	1.25-3	
	Japan Solderless Terminal MFG CO., LTD.	V1.25-3	

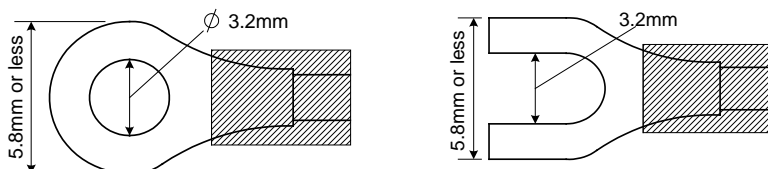

(Fig. 4-2)

# 5. Setup

Before using this controller, it is necessary to set up the Input type, Alarm type, Control action, etc. according to the users' conditions.

Default values are set as follows.

Input: K –200 to 1370°C, Alarm 1 (A1): No alarm action, Alarm 2 (A2): No alarm action, Reverse (Heating) control action

If the users' specification is the same as the default value of the TP20A, it is not necessary to set up the controller. Proceed to Section "6.1 Main setting mode".

## Turn the power supply to the instrument on.

For approx. 3 seconds after the power is turned on, the MEMO/STEP display is turned off and the PV/SV display indicates sensor input characters and temperature unit. During this time, all outputs and LED indicators are in OFF status.

(Table 5-1)



Sensor input	PV/SV display	
	°C	F
K	℄ ℄ ℄ ℄	℄ ℄ ℄ ℄
J	℄ ℄ ℄ ℄	℄ ℄ ℄ ℄
R	℄ ℄ ℄ ℄	℄ ℄ ℄ ℄
S	℄ ℄ ℄ ℄	℄ ℄ ℄ ℄
B	℄ ℄ ℄ ℄	℄ ℄ ℄ ℄
E	℄ ℄ ℄ ℄	℄ ℄ ℄ ℄
T	℄ ℄ ℄ ℄	℄ ℄ ℄ ℄
N	℄ ℄ ℄ ℄	℄ ℄ ℄ ℄
PL-II	℄ ℄ ℄ ℄	℄ ℄ ℄ ℄
C (W/Re5-26)	℄ ℄ ℄ ℄	℄ ℄ ℄ ℄
Pt100	℄ ℄ ℄ ℄	℄ ℄ ℄ ℄
JPt100	℄ ℄ ℄ ℄	℄ ℄ ℄ ℄
4 to 20mA DC	℄ ℄ ℄ ℄	
0 to 20mA DC	℄ ℄ ℄ ℄	
0 to 1V DC	℄ ℄ ℄ ℄	
0 to 5V DC	℄ ℄ ℄ ℄	
1 to 5V DC	℄ ℄ ℄ ℄	
0 to 10V DC	℄ ℄ ℄ ℄	

After that, the following is indicated.



The MEMO/STEP display indicates a memory number.  
The PV/SV display indicates an input value (e.g. room temperature).  
This is the PV/SV display mode.

## Basic operation for setup

Setup is conducted in Auxiliary function setup mode 2.

To enter Auxiliary function setup mode 2, press the  $\Delta$  key for approx. 3 seconds while holding down the  $\nabla$  key in the PV/SV display mode.

Set or select the values with  $\Delta$  and  $\nabla$  key.

Register the values with the  $\text{CLOCK}$  key.

## Display used for explaining setting items

Setting items (Chapter "5 Setup" and setting modes from Sections 6.1 to 6.3) are explained as follows.

(e.g.) Input type selection







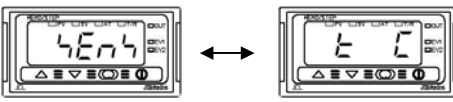
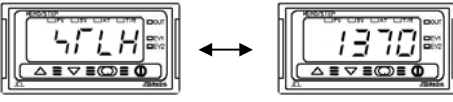
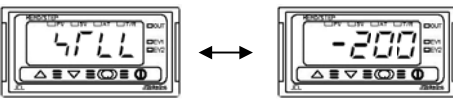
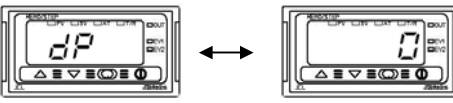

$\longleftrightarrow$  means that input characters 4En4 and selected type ℄ ℄ ℄ ℄ (K, –200 to 1370°C) are indicated alternately.

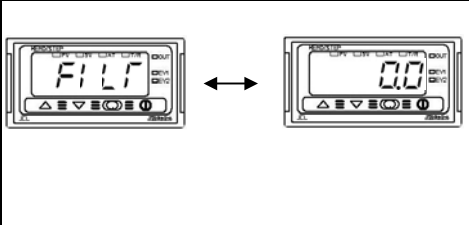
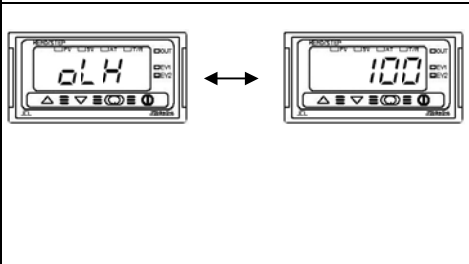
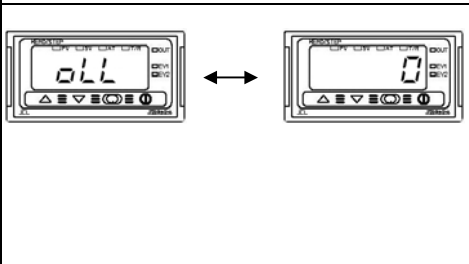
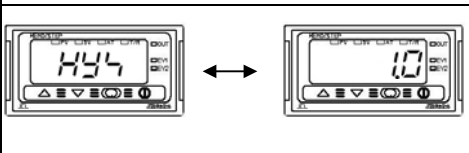
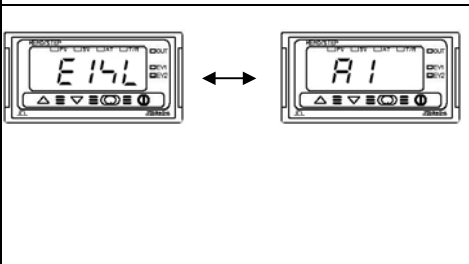
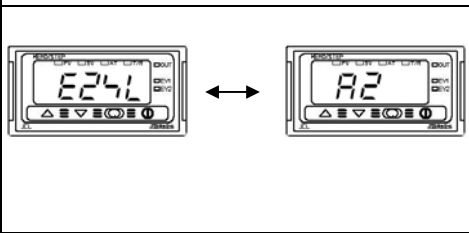
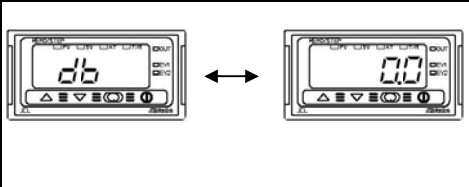
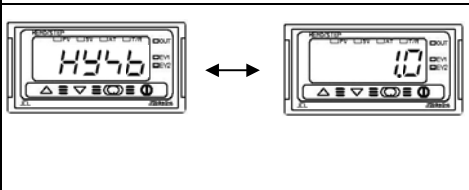

## Auxiliary function setting mode 2

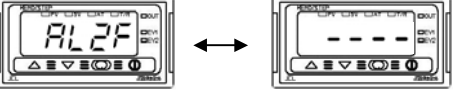
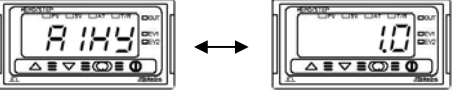
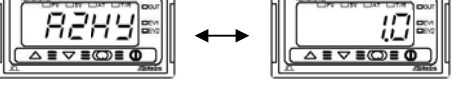
Display	Item, Function, Setting range	Default value																																	
	<b>Input type selection</b> <ul style="list-style-type: none"> <li>The input type can be selected from thermocouple (10 types), RTD (2 types), DC current (2 types) and DC voltage (4 types). The unit °C/°F can be selected as well.</li> <li><b>When changing the input from DC voltage to other inputs, remove the sensor connected to this controller first, then change for the input. If the input is changed with the sensor connected, the input circuit may be broken.</b></li> </ul>	K (-200 to 1370°C)																																	
	<table border="0"> <tr><td><i>E</i>□□□:</td><td>K</td><td>-200 to 1370 °C</td></tr> <tr><td><i>E</i>□□.</td><td></td><td>-199.9 to 400.0°C</td></tr> <tr><td><i>J</i>□□□:</td><td>J</td><td>-200 to 1000 °C</td></tr> <tr><td><i>r</i>□□□:</td><td>R</td><td>0 to 1760 °C</td></tr> <tr><td><i>S</i>□□□:</td><td>S</td><td>0 to 1760 °C</td></tr> <tr><td><i>b</i>□□□:</td><td>B</td><td>0 to 1820 °C</td></tr> <tr><td><i>E</i>□□□:</td><td>E</td><td>-200 to 800 °C</td></tr> <tr><td><i>T</i>□□□:</td><td>T</td><td>-199.9 to 400.0°C</td></tr> <tr><td><i>N</i>□□□:</td><td>N</td><td>-200 to 1300 °C</td></tr> <tr><td><i>PL2</i>□:</td><td>PL-Ⅱ</td><td>0 to 1390 °C</td></tr> <tr><td><i>C</i>□□□:</td><td>C (W/Re5-26)</td><td>0 to 2315 °C</td></tr> </table>	<i>E</i> □□□:	K	-200 to 1370 °C	<i>E</i> □□.		-199.9 to 400.0°C	<i>J</i> □□□:	J	-200 to 1000 °C	<i>r</i> □□□:	R	0 to 1760 °C	<i>S</i> □□□:	S	0 to 1760 °C	<i>b</i> □□□:	B	0 to 1820 °C	<i>E</i> □□□:	E	-200 to 800 °C	<i>T</i> □□□:	T	-199.9 to 400.0°C	<i>N</i> □□□:	N	-200 to 1300 °C	<i>PL2</i> □:	PL-Ⅱ	0 to 1390 °C	<i>C</i> □□□:	C (W/Re5-26)	0 to 2315 °C	
<i>E</i> □□□:	K	-200 to 1370 °C																																	
<i>E</i> □□.		-199.9 to 400.0°C																																	
<i>J</i> □□□:	J	-200 to 1000 °C																																	
<i>r</i> □□□:	R	0 to 1760 °C																																	
<i>S</i> □□□:	S	0 to 1760 °C																																	
<i>b</i> □□□:	B	0 to 1820 °C																																	
<i>E</i> □□□:	E	-200 to 800 °C																																	
<i>T</i> □□□:	T	-199.9 to 400.0°C																																	
<i>N</i> □□□:	N	-200 to 1300 °C																																	
<i>PL2</i> □:	PL-Ⅱ	0 to 1390 °C																																	
<i>C</i> □□□:	C (W/Re5-26)	0 to 2315 °C																																	
	<table border="0"> <tr><td><i>PT</i>□□:</td><td>Pt100</td><td>-199.9 to 850.0°C</td></tr> <tr><td><i>JPT</i>□:</td><td>JPt100</td><td>-199.9 to 500.0°C</td></tr> <tr><td><i>PT</i>□□:</td><td>Pt100</td><td>-200 to 850 °C</td></tr> <tr><td><i>JPT</i>□:</td><td>JPt100</td><td>-200 to 500 °C</td></tr> </table>	<i>PT</i> □□:	Pt100	-199.9 to 850.0°C	<i>JPT</i> □:	JPt100	-199.9 to 500.0°C	<i>PT</i> □□:	Pt100	-200 to 850 °C	<i>JPT</i> □:	JPt100	-200 to 500 °C																						
<i>PT</i> □□:	Pt100	-199.9 to 850.0°C																																	
<i>JPT</i> □:	JPt100	-199.9 to 500.0°C																																	
<i>PT</i> □□:	Pt100	-200 to 850 °C																																	
<i>JPT</i> □:	JPt100	-200 to 500 °C																																	
	<table border="0"> <tr><td><i>E</i>□□□:</td><td>K</td><td>-320 to 2500 °F</td></tr> <tr><td><i>E</i>□□.</td><td></td><td>-199.9 to 750.0°F</td></tr> <tr><td><i>J</i>□□□:</td><td>J</td><td>-320 to 1800 °F</td></tr> <tr><td><i>r</i>□□□:</td><td>R</td><td>0 to 3200 °F</td></tr> <tr><td><i>S</i>□□□:</td><td>S</td><td>0 to 3200 °F</td></tr> <tr><td><i>b</i>□□□:</td><td>B</td><td>0 to 3300 °F</td></tr> <tr><td><i>E</i>□□□:</td><td>E</td><td>-320 to 1500 °F</td></tr> <tr><td><i>T</i>□□□:</td><td>T</td><td>-199.9 to 750.0°F</td></tr> <tr><td><i>N</i>□□□:</td><td>N</td><td>-320 to 2300 °F</td></tr> <tr><td><i>PL2</i>□:</td><td>PL-Ⅱ</td><td>0 to 2500 °F</td></tr> <tr><td><i>C</i>□□□:</td><td>C (W/Re5-26)</td><td>0 to 4200 °F</td></tr> </table>	<i>E</i> □□□:	K	-320 to 2500 °F	<i>E</i> □□.		-199.9 to 750.0°F	<i>J</i> □□□:	J	-320 to 1800 °F	<i>r</i> □□□:	R	0 to 3200 °F	<i>S</i> □□□:	S	0 to 3200 °F	<i>b</i> □□□:	B	0 to 3300 °F	<i>E</i> □□□:	E	-320 to 1500 °F	<i>T</i> □□□:	T	-199.9 to 750.0°F	<i>N</i> □□□:	N	-320 to 2300 °F	<i>PL2</i> □:	PL-Ⅱ	0 to 2500 °F	<i>C</i> □□□:	C (W/Re5-26)	0 to 4200 °F	
<i>E</i> □□□:	K	-320 to 2500 °F																																	
<i>E</i> □□.		-199.9 to 750.0°F																																	
<i>J</i> □□□:	J	-320 to 1800 °F																																	
<i>r</i> □□□:	R	0 to 3200 °F																																	
<i>S</i> □□□:	S	0 to 3200 °F																																	
<i>b</i> □□□:	B	0 to 3300 °F																																	
<i>E</i> □□□:	E	-320 to 1500 °F																																	
<i>T</i> □□□:	T	-199.9 to 750.0°F																																	
<i>N</i> □□□:	N	-320 to 2300 °F																																	
<i>PL2</i> □:	PL-Ⅱ	0 to 2500 °F																																	
<i>C</i> □□□:	C (W/Re5-26)	0 to 4200 °F																																	
	<table border="0"> <tr><td><i>PT</i>□□:</td><td>Pt100</td><td>-199.9 to 999.9°F</td></tr> <tr><td><i>JPT</i>□:</td><td>JPt100</td><td>-199.9 to 900.0°F</td></tr> <tr><td><i>PT</i>□□:</td><td>Pt100</td><td>-300 to 1500 °F</td></tr> <tr><td><i>JPT</i>□:</td><td>JPt100</td><td>-300 to 900 °F</td></tr> </table>	<i>PT</i> □□:	Pt100	-199.9 to 999.9°F	<i>JPT</i> □:	JPt100	-199.9 to 900.0°F	<i>PT</i> □□:	Pt100	-300 to 1500 °F	<i>JPT</i> □:	JPt100	-300 to 900 °F																						
<i>PT</i> □□:	Pt100	-199.9 to 999.9°F																																	
<i>JPT</i> □:	JPt100	-199.9 to 900.0°F																																	
<i>PT</i> □□:	Pt100	-300 to 1500 °F																																	
<i>JPT</i> □:	JPt100	-300 to 900 °F																																	
	<table border="0"> <tr><td><i>420A</i>:</td><td>4 to 20mA DC</td><td>-1999 to 9999</td></tr> <tr><td><i>020A</i>:</td><td>0 to 20mA DC</td><td>-1999 to 9999</td></tr> <tr><td><i>01V</i>:</td><td>0 to 1V DC</td><td>-1999 to 9999</td></tr> <tr><td><i>05V</i>:</td><td>0 to 5V DC</td><td>-1999 to 9999</td></tr> <tr><td><i>15V</i>:</td><td>1 to 5V DC</td><td>-1999 to 9999</td></tr> <tr><td><i>010V</i>:</td><td>0 to 10V DC</td><td>-1999 to 9999</td></tr> </table>	<i>420A</i> :	4 to 20mA DC	-1999 to 9999	<i>020A</i> :	0 to 20mA DC	-1999 to 9999	<i>01V</i> :	0 to 1V DC	-1999 to 9999	<i>05V</i> :	0 to 5V DC	-1999 to 9999	<i>15V</i> :	1 to 5V DC	-1999 to 9999	<i>010V</i> :	0 to 10V DC	-1999 to 9999																
<i>420A</i> :	4 to 20mA DC	-1999 to 9999																																	
<i>020A</i> :	0 to 20mA DC	-1999 to 9999																																	
<i>01V</i> :	0 to 1V DC	-1999 to 9999																																	
<i>05V</i> :	0 to 5V DC	-1999 to 9999																																	
<i>15V</i> :	1 to 5V DC	-1999 to 9999																																	
<i>010V</i> :	0 to 10V DC	-1999 to 9999																																	
	<b>Scaling high limit setting</b> <ul style="list-style-type: none"> <li>Sets scaling high limit value.</li> <li>Setting range: Scaling low limit value to input range high limit value</li> </ul>	1370°C																																	
	<b>Scaling low limit setting</b> <ul style="list-style-type: none"> <li>Sets scaling low limit value.</li> <li>Setting range: Input range low limit value to scaling high limit value</li> </ul>	-200°C																																	
	<b>Decimal point place selection</b> <ul style="list-style-type: none"> <li>Selects decimal point place.</li> <li>Available only for DC input</li> <li>□□□□: No decimal point</li> <li>□□□.: 1 digit after decimal point</li> <li>□□□.□: 2 digits after decimal point</li> <li>□□□.□□: 3 digits after decimal point</li> </ul>	No decimal point																																	

	<p><b>PV filter time constant setting</b></p> <ul style="list-style-type: none"> <li>• Sets PV filter time constant. Input fluctuation due to the noise can be reduced. <b>If the value is set too large, it affects control result due to the delay of response.</b></li> <li>• Setting range: 0.0 to 10.0 seconds</li> </ul>	<p>0.0 seconds</p>
	<p><b>OUT1 high limit setting</b></p> <ul style="list-style-type: none"> <li>• Sets OUT1 high limit value. Not available when OUT1 is ON/OFF action</li> <li>• If DR option is added, OUT terminals are used for Heating output terminals.</li> <li>• Setting range: OUT1 low limit value to 100% (DC current output type: OUT1 low limit value to 105%)</li> </ul>	<p>100%</p>
	<p><b>OUT1 low limit setting</b></p> <ul style="list-style-type: none"> <li>• Sets OUT1 low limit value. Not available when OUT1 is ON/OFF action</li> <li>• If DR option is added, OUT terminals are used for Heating output terminals.</li> <li>• Setting range: 0% to OUT1 high limit value (DC current output type: -5% to OUT1 high limit value)</li> </ul>	<p>0%</p>
	<p><b>OUT1 ON/OFF action hysteresis setting</b></p> <ul style="list-style-type: none"> <li>• Sets ON/OFF action hysteresis for OUT1.</li> <li>• Available only when OUT1 is ON/OFF action</li> <li>• Setting range: 0.1 to 100.0°C (°F), or 1 to 1000</li> </ul>	<p>1.0°C</p>
	<p><b>EV1 output selection</b></p> <ul style="list-style-type: none"> <li>• Selects a function for EV1 output terminals.</li> <li>• Not available if DR option is added, since EV1 terminals are used for Cooling output terminals.</li> <li>• <b>A1</b>: A1 output <b>A2</b>: A2 output <b>or</b>: Common to A1 and A2 output</li> </ul>	<p>A1 output</p>
	<p><b>EV2 output selection</b></p> <ul style="list-style-type: none"> <li>• Selects a function for EV2 output terminals.</li> <li>• Not available if C5 option is added</li> <li>• <b>A1</b>: A1 output <b>A2</b>: A2 output <b>or</b>: Common to A1 and A2 output</li> </ul>	<p>A2 output</p>
	<p><b>Overlap band/Dead band setting</b></p> <ul style="list-style-type: none"> <li>• Sets the overlap band or dead band for OUT1 and OUT2. + Set value: Dead band, - Set value: Overlap band</li> <li>• Available only when the DR option is added</li> <li>• Setting range: -100.0 to 100.0°C (°F), or 1 to 1000</li> </ul>	<p>0.0°C</p>
	<p><b>OUT2 ON/OFF action hysteresis setting</b></p> <ul style="list-style-type: none"> <li>• Sets ON/OFF action hysteresis for OUT2.</li> <li>• Available only when the DR option is added, and when OUT2 is ON/OFF action</li> <li>• Setting range: 0.1 to 100.0°C (°F), or 1 to 1000</li> </ul>	<p>1.0°C</p>

	<p><b>A1 type selection</b></p> <ul style="list-style-type: none"> <li>• Selects an Alarm 1 (A1) type.</li> <li>• -----: No alarm action</li> <li>• H---: High limit alarm</li> <li>• L---: Low limit alarm</li> <li>• HL--: High/Low limits alarm</li> <li>• U L d: High/Low limit range alarm</li> <li>• R4--: Process high alarm</li> <li>• rR4--: Process low alarm</li> <li>• H---: High limit alarm with standby</li> <li>• L---: Low limit alarm with standby</li> <li>• HL---: High/Low limits alarm with standby</li> <li>• rrr: Timer function</li> <li>• PEnd: Pattern end output</li> </ul> <p><b>If Timer function is selected, Timer function works only when Delay action type, Delay time and DI (digital input) function are set (selected).</b></p> <p><b>Note: If an alarm type is changed, the alarm set value becomes 0 (0.0). Therefore it is necessary to reset it.</b></p>	<p>No alarm action</p>
	<p><b>A2 type selection</b></p> <ul style="list-style-type: none"> <li>• Selects an Alarm 2 (A2) type.</li> <li>• Types and action are the same as those of A1 type selection.</li> </ul> <p><b>Note: If an alarm type is changed, the alarm set value becomes 0 (0.0). Therefore it is necessary to reset it.</b></p>	<p>No alarm action</p>
	<p><b>A1 hysteresis setting</b></p> <ul style="list-style-type: none"> <li>• Sets hysteresis for A1.</li> <li>• Not available if No alarm action, Timer function or Pattern end output is selected during A1 type selection</li> <li>• Setting range: 0.1 to 100.0°C(°F), or 1 to 1000</li> </ul>	<p>1.0°C</p>
	<p><b>A2 hysteresis setting</b></p> <ul style="list-style-type: none"> <li>• Sets hysteresis for A2.</li> <li>• Not available if No alarm action, Timer function or Pattern end output is selected during A2 type selection</li> <li>• Setting range: 0.1 to 100.0°C(°F), or 1 to 1000</li> </ul>	<p>1.0°C</p>
	<p><b>A1 action delayed timer setting</b></p> <ul style="list-style-type: none"> <li>• Sets action delayed timer for A1.</li> <li>• When setting time has elapsed after the input enters the alarm output range, the alarm is activated.</li> <li>• Not available if No alarm action, Timer function or Pattern end output is selected during A1 type selection</li> <li>• Setting range: 0 to 9999 seconds</li> </ul>	<p>0 seconds</p>
	<p><b>A2 action delayed timer setting</b></p> <ul style="list-style-type: none"> <li>• Sets action delayed timer for A2.</li> <li>• When setting time has elapsed after the input enters the alarm output range, the alarm is activated.</li> <li>• Not available if No alarm action, Timer function or Pattern end output is selected during A2 type selection</li> <li>• Setting range: 0 to 9999 seconds</li> </ul>	<p>0 seconds</p>
	<p><b>Alarm HOLD function selection</b></p> <ul style="list-style-type: none"> <li>• Selects whether alarm HOLD function for A1 or A2 is Holding or Not holding.</li> <li>• This setting item is common to A1 and A2.</li> <li>• Not available if No alarm action, Timer function or Pattern end output is selected during A1 and A2 type selection.</li> <li>• none: Alarm Not holding</li> <li>• Hold: Alarm Holding</li> </ul>	<p>Alarm Holding</p>

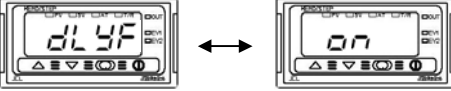
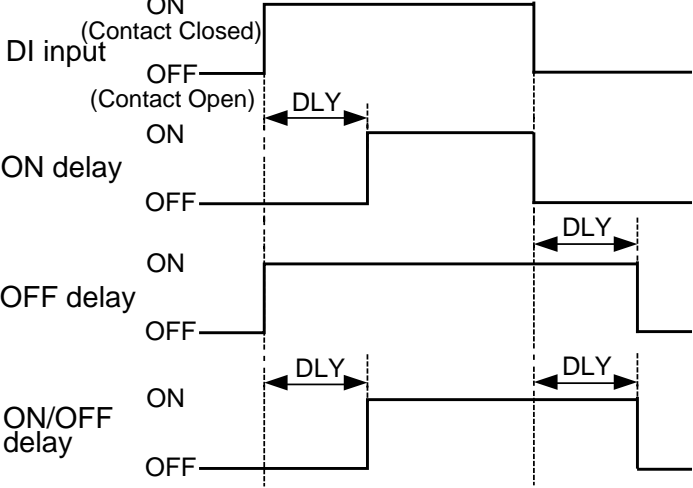
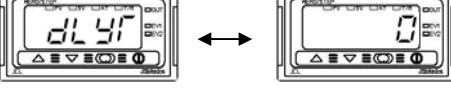
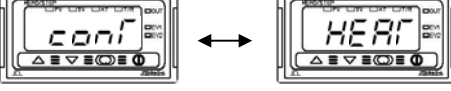
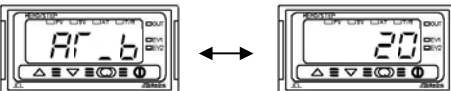
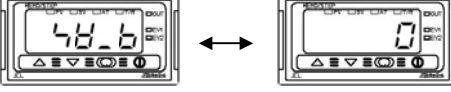
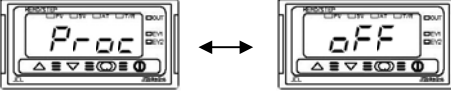
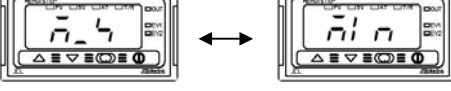
	<p><b>Delay action type selection</b> <span style="float: right;">ON delay</span></p> <ul style="list-style-type: none"> <li>• Selects a delay action type for Timer function.</li> <li>• Available only when Timer function is selected during A1 and A2 action selection.</li> <li>• <i>on</i>: ON delay</li> <li>• <i>off</i>: OFF delay</li> <li>• <i>onof</i>: ON/OFF delay</li> </ul>  <p style="text-align: center;">DLY: Delay time setting (Fig. 5.6-1)</p>
	<p><b>Delay time setting</b> <span style="float: right;">0 seconds</span></p> <ul style="list-style-type: none"> <li>• Sets delay time for the Timer function.</li> <li>• Available only when Timer function is selected during A1, A2 action selection.</li> <li>• Setting range: 0 to 9999 seconds</li> </ul>
	<p><b>Direct/Reverse control action selection</b> <span style="float: right;">Reverse (Heating)</span></p> <ul style="list-style-type: none"> <li>• Selects Reverse (Heating) or Direct (Cooling) control action.</li> <li>• <i>HEAT</i>: Reverse (Heating) action</li> <li>• <i>cool</i>: Direct (Cooling) action</li> </ul>
	<p><b>AT bias setting</b> <span style="float: right;">20°C</span></p> <ul style="list-style-type: none"> <li>• Sets bias value when performing auto-tuning.</li> <li>• Sets the bias value by which AT point is automatically decided by the deviation between PV and SV.</li> <li>• Not available for DC input</li> <li>• Setting range: 0 to 50°C (0 to 100°F) or 0.0 to 50.0°C (0.0 to 100.0°F)</li> </ul>
	<p><b>SVTC bias setting</b> <span style="float: right;">0</span></p> <ul style="list-style-type: none"> <li>• Control desired value (SV) adds SVTC bias value to the value received by the SVTC command.</li> <li>• Available only when C5 option is added</li> <li>• Setting range: ±20% of the scaling span</li> </ul>
	<p><b>OUT/OFF key function selection</b> <span style="float: right;">Control output OUT/OFF function</span></p> <ul style="list-style-type: none"> <li>• Selects whether OUT/OFF key is used for control output OUT/OFF function (Fixed value control) or for program control RUN/STOP function.</li> <li>• <i>off</i>: Control output OUT/OFF function (Fixed value control)</li> <li>• <i>Proc</i>: Program control RUN/STOP function</li> </ul>
	<p><b>Step time unit selection</b> <span style="float: right;">Hour:Minute</span></p> <ul style="list-style-type: none"> <li>• Selects Step time unit for the program control function.</li> <li>• Not available when control output OUT/OFF function (Fixed value control) is selected during [OUT/OFF key function selection].</li> <li>• <i>7:17</i>: Hour:Minute</li> <li>• <i>7Ec</i>: Minute:Second</li> </ul>

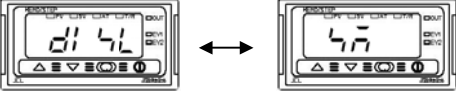
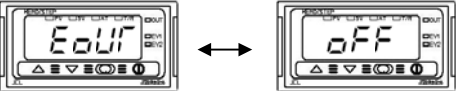
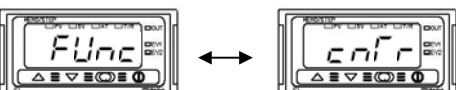
	<p><b>DI (Digital input) function selection</b></p> <ul style="list-style-type: none"> <li>• Selects DI function whether it is used as SV1/SV2 external selection function, OUT/OFF (RUN/STOP) external selection function or a timer function.</li> </ul> <p><b>If SV1/SV2 external selection function is selected;</b>  SV1 or SV2 can be switched by external contact.  However, this function is not available if Program control function is selected during OUT/OFF key function selection.  Between DI terminals Open: SV1  Between DI terminals Closed: SV2</p> <p><b>If OUT/OFF(RUN/STOP) external selection function is selected;</b>  Control output OUT/OFF (Fixed value control) or Program control RUN/STOP can be switched.</p> <p><b>Fixed value control</b>  Between DI terminals Open: OUT (Control allowed)  Between DI terminals Closed: OFF (Control prohibited, control output OFF)</p> <p><b>Program control</b>  Program control RUN/STOP can be switched by external contact pulse input (ON time, approx. 30ms).  If pulse input enters during program control standby, program control starts.  If pulse input enters during program control run, program control stops and the controller reverts to the program control standby mode.  If pulse input enters while pattern end output is turned on after program control ended, pattern end output is turned off.</p> <p><b>If Timer function is selected;</b>  Timer counting starts by the external contact, and after the set delay time has passed, the selected event output is turned on.</p> <ul style="list-style-type: none"> <li>• Not available if C5 option is applied.</li> <li>• <code>4n</code>: SV1/SV2 external selection function</li> <li>• <code>ouff</code>: OUT/OFF (RUN/STOP) external selection function</li> <li>• <code>trr</code>: Timer function</li> </ul>	<p>SV1/SV2 external selection function</p>
	<p><b>Output status selection when input abnormal</b></p> <ul style="list-style-type: none"> <li>• Selects the output status of OUT1 and EV1/OUT2 when DC input is overscale or underscale. See "Input abnormality indication" (p.28).</li> <li>• Available only for DC current output type with DC input</li> <li>• <code>off</code>: OUT1 outputs OFF(4mA) or OUT1 low limit value. EV1/OUT2: OFF</li> <li>• <code>on</code>: OUT1 outputs a value between OFF(4mA) and ON(20mA), or outputs a value between OUT1 low limit value and OUT1 high limit value. EV1/OUT2: ON</li> </ul>	<p>Output OFF</p>
	<p><b>Controller/Converter function selection</b></p> <ul style="list-style-type: none"> <li>• Selects whether to use the TP20A as a controller or a converter.</li> <li>• If the TP20A is switched from a converter to a controller, control parameters which were automatically set when converter function was selected are maintained as they were. Therefore correct the values when using the TP20A as a controller.</li> <li>• Available only for DC current output type</li> <li>• <code>cntr</code>: Controller</li> <li>• <code>cnbl</code>: Converter</li> </ul>	<p>Controller</p>

# 6. Settings

## 6.1 Main setting mode

To enter the main setting mode, press the  key in the PV/SV display mode.

Set each setting item with the  $\Delta$  or  $\nabla$  key, and register the value with the  key.

In the main setting mode, indicated setting items depend on the instrument status (Fixed value control or Program control).

- Fixed value control

Setting items SV1 and SV2 will be indicated.

- Program control



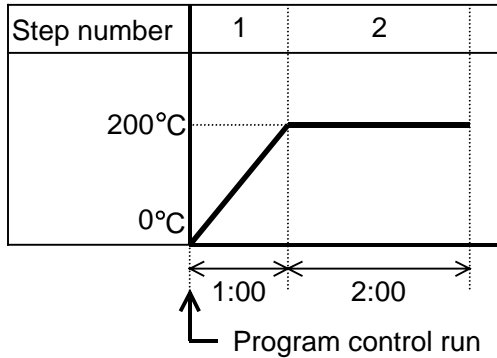











Step SV and step time for 1 to 9 steps will be indicated.



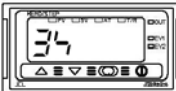













This program pattern shows that the temperature rises to 200°C for 1 hour and stays at 200°C for 2 hours.



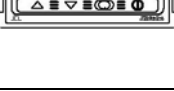
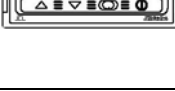
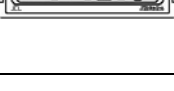
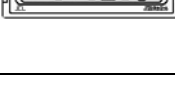

In this case, Step 1 SV is 200°C and Step 1 time is 1 hour.

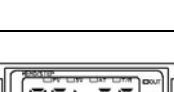
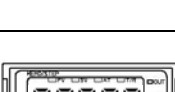
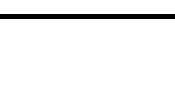
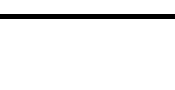





















Program control run (Fig.6.1-1)

Display	Item, Function, Setting range	Default value
 ↔ 	<b>SV1 (step 1 SV) setting</b> • Sets SV1 or step 1 SV. • Scaling low limit value to Scaling high limit value	0°C
 ↔ 	<b>Step 1 time setting</b> • Sets step 1 time. • Available only when program control function is selected during OUT/OFF key function selection • Setting range: 00:00 to 99:59	00:00
 ↔ 	<b>SV2 (step 2 SV) setting</b> • Sets SV2 or step 2 SV. • Available when SV1/SV2 external selection function is selected during DI (digital input) function selection or when program control function is selected during OUT/OFF key function selection. • Scaling low limit value to Scaling high limit value	0°C
 ↔ 	<b>Step 2 time setting</b> • Sets step 2 time. • Available only when program control function is selected during OUT/OFF key function selection • Setting range: 00:00 to 99:59	00:00
 ↔ 	<b>Step 3 SV setting</b> • Sets step 3 SV. • Available only when program control function is selected during OUT/OFF key function selection • Scaling low limit value to Scaling high limit value	0°C
 ↔ 	<b>Step 3 time setting</b> • Sets step 3 time. • Available only when program control function is selected during OUT/OFF key function selection • Setting range: 00:00 to 99:59	00:00
 ↔ 	<b>Step 4 SV setting</b> • Sets step 4 SV. • Available only when program control function is selected during OUT/OFF key function selection • Scaling low limit value to Scaling high limit value	0°C

 	<p><b>Step 4 time setting</b></p> <ul style="list-style-type: none"> <li>• Sets step 4 time.</li> <li>• Available only when program control function is selected during OUT/OFF key function selection</li> <li>• Setting range: 00:00 to 99:59</li> </ul>	00:00
 	<p><b>Step 5 SV setting</b></p> <ul style="list-style-type: none"> <li>• Sets step 5 SV.</li> <li>• Available only when program control function is selected during OUT/OFF key function selection</li> <li>• Scaling low limit value to Scaling high limit value</li> </ul>	0°C
 	<p><b>Step 5 time setting</b></p> <ul style="list-style-type: none"> <li>• Sets step 5 time.</li> <li>• Available only when program control function is selected during OUT/OFF key function selection</li> <li>• Setting range: 00:00 to 99:59</li> </ul>	00:00
 	<p><b>Step 6 SV setting</b></p> <ul style="list-style-type: none"> <li>• Sets step 6 SV.</li> <li>• Available only when program control function is selected during OUT/OFF key function selection</li> <li>• Scaling low limit value to Scaling high limit value</li> </ul>	0°C
 	<p><b>Step 6 time setting</b></p> <ul style="list-style-type: none"> <li>• Sets step 6 time.</li> <li>• Available only when program control function is selected during OUT/OFF key function selection</li> <li>• Setting range: 00:00 to 99:59</li> </ul>	00:00
 	<p><b>Step 7 SV setting</b></p> <ul style="list-style-type: none"> <li>• Sets step 7 SV.</li> <li>• Available only when program control function is selected during OUT/OFF key function selection</li> <li>• Scaling low limit value to Scaling high limit value</li> </ul>	0°C
 	<p><b>Step 7 time setting</b></p> <ul style="list-style-type: none"> <li>• Sets step 7 time.</li> <li>• Available only when program control function is selected during OUT/OFF key function selection</li> <li>• Setting range: 00:00 to 99:59</li> </ul>	00:00
 	<p><b>Step 8 SV setting</b></p> <ul style="list-style-type: none"> <li>• Sets step 8 SV.</li> <li>• Available only when program control function is selected during OUT/OFF key function selection</li> <li>• Scaling low limit value to Scaling high limit value</li> </ul>	0°C
 	<p><b>Step 8 time setting</b></p> <ul style="list-style-type: none"> <li>• Sets step 8 time.</li> <li>• Available only when program control function is selected during OUT/OFF key function selection</li> <li>• Setting range: 00:00 to 99:59</li> </ul>	00:00
 	<p><b>Step 9 step SV setting</b></p> <ul style="list-style-type: none"> <li>• Sets step 9 SV.</li> <li>• Available only when program control function is selected during OUT/OFF key function selection</li> <li>• Scaling low limit value to Scaling high limit value</li> </ul>	0°C
 	<p><b>Step 9 time setting</b></p> <ul style="list-style-type: none"> <li>• Sets step 9 time.</li> <li>• Available only when program control function is selected during OUT/OFF key function selection</li> <li>• Setting range: 00:00 to 99:59</li> </ul>	00:00

## 6.2 Sub setting mode

To enter the Sub setting mode, press the  key while pressing  key in the PV/SV display mode. Set each setting item with the  or  key, and register the value with the  key.

Display	Item, Function, Setting range	Default value
 ↔ 	<b>AT (Auto-tuning) selection</b> <ul style="list-style-type: none"> <li>• Selects auto-tuning Perform/Cancel.</li> <li>• Not available for program control standby status and for control actions other than PID action.</li> <li>• ---: AT (Auto-tuning) Cancel</li> <li>• AT: AT (Auto-tuning) Perform</li> </ul>	AT Cancel
 ↔ 	<b>OUT1 proportional band setting</b> <ul style="list-style-type: none"> <li>• Sets the proportional band for OUT1.</li> <li>• ON/OFF action when set to 0.0.</li> <li>• Setting range: 0.0 to 110.0%</li> </ul>	2.5%
 ↔ 	<b>OUT2 proportional band setting</b> <ul style="list-style-type: none"> <li>• Sets the proportional band for OUT2.</li> <li>• ON/OFF action when set to 0.0.</li> <li>• Not available if DR option is not added or if OUT1 is ON/OFF action</li> <li>• Setting range: 0.0 to 10.0 times OUT1 proportional band</li> </ul>	1.0 times
 ↔ 	<b>Integral time setting</b> <ul style="list-style-type: none"> <li>• Sets the integral time for OUT1.</li> <li>• Setting the value to 0 disables the function. (PD action)</li> <li>• Not available if OUT1 is ON/OFF action</li> <li>• Setting range: 0 to 1000 seconds</li> </ul>	200 seconds
 ↔ 	<b>Derivative time setting</b> <ul style="list-style-type: none"> <li>• Sets the derivative time for OUT1.</li> <li>• Setting the value to 0 disables the function. (PI action)</li> <li>• Not available if OUT1 is ON/OFF action</li> <li>• Setting range: 0 to 300 seconds</li> </ul>	50 seconds
 ↔ 	<b>ARW setting</b> <ul style="list-style-type: none"> <li>• Sets the ARW (anti-reset windup) for OUT1.</li> <li>• Available only for PID action.</li> <li>• Setting range: 0 to 100%</li> </ul>	50%
 ↔ 	<b>OUT1 proportional cycle setting</b> <ul style="list-style-type: none"> <li>• Sets OUT1 proportional cycle.</li> <li>• Not available for DC current output type or if OUT1 is ON/OFF action.</li> <li>• Setting range: 1 to 120 seconds</li> </ul>	Relay contact: 30sec Non-contact voltage: 3sec DC current: Not available
 ↔ 	<b>OUT2 proportional cycle setting</b> <ul style="list-style-type: none"> <li>• Sets OUT2 proportional cycle.</li> <li>• Not available when DR option is not added or if OUT2 is ON/OFF action.</li> <li>• Setting range: 1 to 120 seconds</li> </ul>	30 seconds
 ↔ 	<b>Manual reset setting</b> <ul style="list-style-type: none"> <li>• Sets reset value manually.</li> <li>• Available only for P or PD action.</li> <li>• ±Proportional band converted value (For DC input, the placement of the decimal point follows the selection.)</li> </ul>	0.0°C
 ↔ 	<b>A1 value setting</b> <ul style="list-style-type: none"> <li>• Sets A1 action point.</li> <li>• Not available if No alarm action, Timer function or Pattern end output is selected during A1 type selection</li> <li>• Setting the value to 0 or 0.0 disables the function (except Process high and Process low alarm).</li> <li>• Setting range: See (Table 6.2-1) on page 17.</li> </ul>	0°C
 ↔ 	<b>A2 value setting</b> <ul style="list-style-type: none"> <li>• Sets A2 action point.</li> <li>• Not available if No alarm action, Timer function or Pattern end output is selected during A2 type selection</li> <li>• Setting the value to 0 or 0.0 disables the function (except Process high and Process low alarm).</li> <li>• Setting range: See (Table 6.2-1) on page 17.</li> </ul>	0°C





(Table 6.2-1)

Alarm type	Setting range
High limit alarm	-(Scaling span) to Scaling span
Low limit alarm	-(Scaling span) to Scaling span
High/Low limits alarm	0 to Scaling span
High/Low limit range alarm	0 to Scaling span
Process high alarm	Scaling low limit to Scaling high limit value
Process low alarm	Scaling low limit to Scaling high limit value
High limit alarm with standby	-(Scaling span) to Scaling span
Low limit alarm with standby	-(Scaling span) to Scaling span
High/Low limits alarm w/standby	0 to Scaling span



For the inputs with a decimal point, the negative low limit value is -199.9, and the positive high limit value is 999.9.

All alarm types except for the Process alarm are  $\pm$  deviation setting from the SV (main set value).

### 6.3 Auxiliary function setting mode 1

To enter Auxiliary function setting mode 1, press the  key for approx. 3 seconds while holding down  key in the PV/SV display mode.

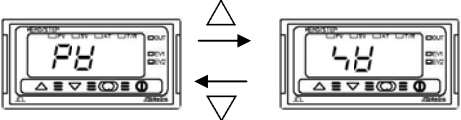
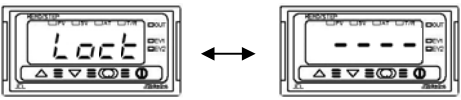
Set each setting item with the  or  key, and register the value with the  key.

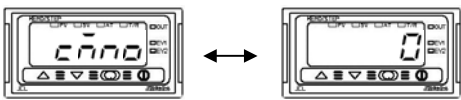
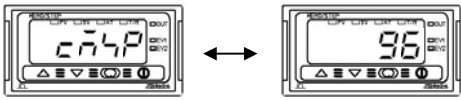
Display	Item, Function, Setting range	Default value
	<b>PV/SV indication selection</b> <ul style="list-style-type: none"> <li>PV indication (<i>PB</i>) or SV indication (<i>48</i>) can be selected.</li> <li>During input abnormality, the PV/SV display flashes "----" or "----" even if SV is indicated on the display.</li> </ul>	PV indication
	<b>Set value lock selection</b> <ul style="list-style-type: none"> <li>Locks the set values to prevent setting errors. The setting item to be locked depends on the selection.</li> <li>When Lock 1 or Lock 2 is selected, PID Auto-tuning cannot be carried out.</li> <li>Because there is limited non-volatile memory, be sure to select Lock 3 when the set value is changed frequently via communication function.</li> <li>---- (Unlock): All set values can be changed.</li> <li><i>Loc 1</i> (Lock 1): None of the set values can be changed.</li> <li><i>Loc 2</i> (Lock 2): SV1 and SV2 can be changed during fixed value control. Step SV and step time can be changed during program control. Other setting items cannot be changed.</li> <li><i>Loc 3</i> (Lock 3): All set values except Input type and Controller/Converter function can be changed. However, changed values revert to their previous values after power-off because they are not saved in the non-volatile memory.</li> </ul> <p><b>Do not change any setting item in Auxiliary function setting mode 2. If any item in Auxiliary function setting mode 2 is changed, it will affect other setting items such as the SV and Alarm value.</b></p>	Unlock
	<b>Sensor correction setting</b> <ul style="list-style-type: none"> <li>Sets the correction value for the sensor.</li> <li>PV=Current process temperature + Sensor correction value</li> <li>Setting range: -100.0 to 100.0°C (°F), or -1000 to 1000</li> </ul>	0.0°C
	<b>Communication protocol selection</b> <ul style="list-style-type: none"> <li>Selects communication protocol.</li> <li>Available only when the C5 option is applied.</li> <li><i>004</i>: IMO protocol, <i>00A</i>: Modbus ASCII mode, <i>00R</i>: Modbus RTU mode</li> </ul>	IMO protocol
	<b>Instrument number setting</b> <ul style="list-style-type: none"> <li>Sets the instrument number individually to each instrument when communicating by connecting plural instruments in serial communication.</li> <li>Available only when C5 option is added.</li> <li>Setting range: 0 to 95</li> </ul>	0
	<b>Communication speed selection</b> <ul style="list-style-type: none"> <li>Selects a communication speed equal to the speed of the host computer.</li> <li>Available only when C5 option is added.</li> <li><i>24</i>: 2400bps      <i>48</i>: 4800bps</li> <li><i>96</i>: 9600bps      <i>192</i>: 19200bps</li> </ul>	9600bps

# 7. Running

## 7.1 Start running.

After the controller is mounted to the control panel and wiring is completed, operate the unit following the procedures below.

### (1) Turn the power supply to the TP20A ON.

For approx. 3sec after the power is switched ON, the sensor input characters and the temperature unit are indicated on the PV/SV display. See (Table 5-1) on page 8.

During this time, all outputs and LED indicators are in OFF status.

After that, control starts indicating the following depending on the controller status.

#### • Fixed value control status

Control starts indicating memory number on the MEMO/STEP display and input value (PV) or main set value (SV) on the PV/SV display. (If PV indication is selected during PV/SV indication selection, input value is indicated. If SV indication is selected during PV/SV indication selection, main set value is indicated.)

#### • Program control standby status

The MEMO/STEP display is turned off, and the PV/SV display indicates input value or "4r b3". (If PV indication is selected during PV/SV indication selection, input value is indicated. If SV indication is selected during PV/SV indication selection, "4r b3" is indicated.)

#### • Program control run status

The MEMO/STEP display indicates step number, and the PV/SV display indicates input value or current step temperature. (If PV indication is selected during PV/SV indication selection, input value is indicated. If SV indication is selected during PV/SV indication selection, current step temperature is indicated.)

#### • When control output OFF function is working;

The MEMO/STEP display is turned off, and the PV/SV display indicates "OFF".

### (2) Input each set value.

Input each set value, referring to "6. Settings".

### (3) Turn the load circuit power ON.

The controller starts as follows depending on the setting.

#### • Fixed value control

Control starts so as to keep the control target at the SV.

#### • Program control

##### Program control run

To perform program control run, press the ① key. At this time the program control starts with PV start.

PV start: When the program control starts, SV and step time are advanced to the PV, then the program control is performed.

##### Program control stop

To stop program control, press the ① key for approx. 1 second. The program control stops, and the controller reverts to the program control standby mode.

##### Action after power is restored

If power failure occurs during the program control run, the control resumes from the point at which power failure occurred.

If power failure occurs during program control standby mode, the control resumes from the program control standby mode.

Progressing time error after power is restored: Within  $\pm 1$  minute regardless of step time unit



#### • Converter

Each input value (thermocouple, RTD, DC current, DC voltage) is converted to 4 to 20mA DC and outputted.

Input/output response is approx. 1 second.

When using an alarm action, select "Process alarm" during A1, A2 type selection.

## 7.2 MV (Control output manipulated variable) indication

To indicate MV, hold down the  key for approx. 3 seconds in the PV/SV display mode. Keep pressing the  key until MV appears, though setting item SV1 (step 1 SV) appears during the process.

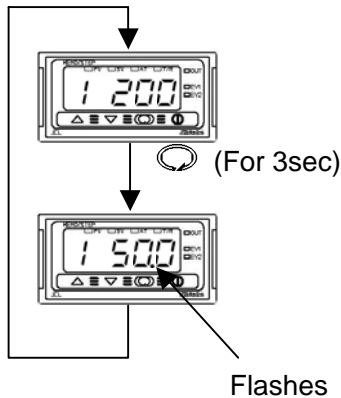

### PV/SV display mode

Hold down the  key for approx. 3 seconds.

Keep pressing the  key until MV appears, though setting item SV1 (step 1 SV) appears during the process.

### MV (Control output manipulated variable) indication

The MEMO/STEP display indicates a memory number during fixed value control and a step number during program control.

The PV/SV display indicates MV.

While MV is being indicated, the 1st decimal point from the right flashes in 0.5 second cycles.

To release MV indication function, press the  key again or turn the power of the TP20A OFF and ON again.

## 7.3 Control output OFF function

This is a function to pause the control action or to turn the control output of the unused instrument of the plural units OFF even if the power to the instrument is supplied.

To turn the control output OFF, press the  key for approx. 1 second in the PV/SV display.

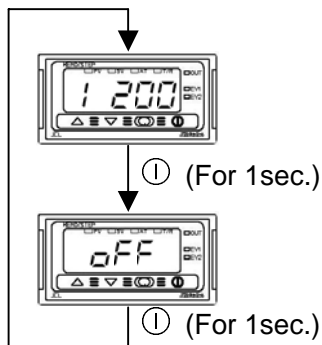

### PV/SV display mode

Press the  key for approx. 1 second.

### Control output OFF

The MEMO/STEP display is turned off and the PV/SV display indicates **off**. Once the control output OFF function is enabled, the function cannot be released even if the power to the instrument is turned OFF and ON again.



To cancel the function, press the  key again for approx. 1 second.

## 7.4 Auto-tuning (AT) Perform/Cancel

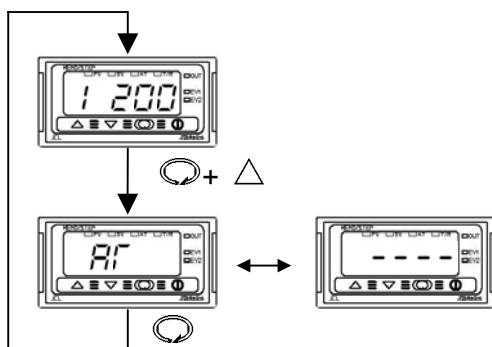

Auto-tuning Perform/Cancel can be selected during AT selection in the Sub setting mode.



### PV/SV display mode

Press the  key while holding down the  key.

### AT selection in the Sub setting mode

Select Auto-tuning Perform (**AT**) with the  key and Auto-tuning Cancel (----) with the  key, then press the  key. The AT indicator flashes while performing auto-tuning.

If Auto-tuning is cancelled during the process, P, I, D, ARW values return to the previous values.

If PID auto-tuning does not finish in 4 hours after starting, PID auto-tuning is cancelled automatically.

# 8. Operation flowchart

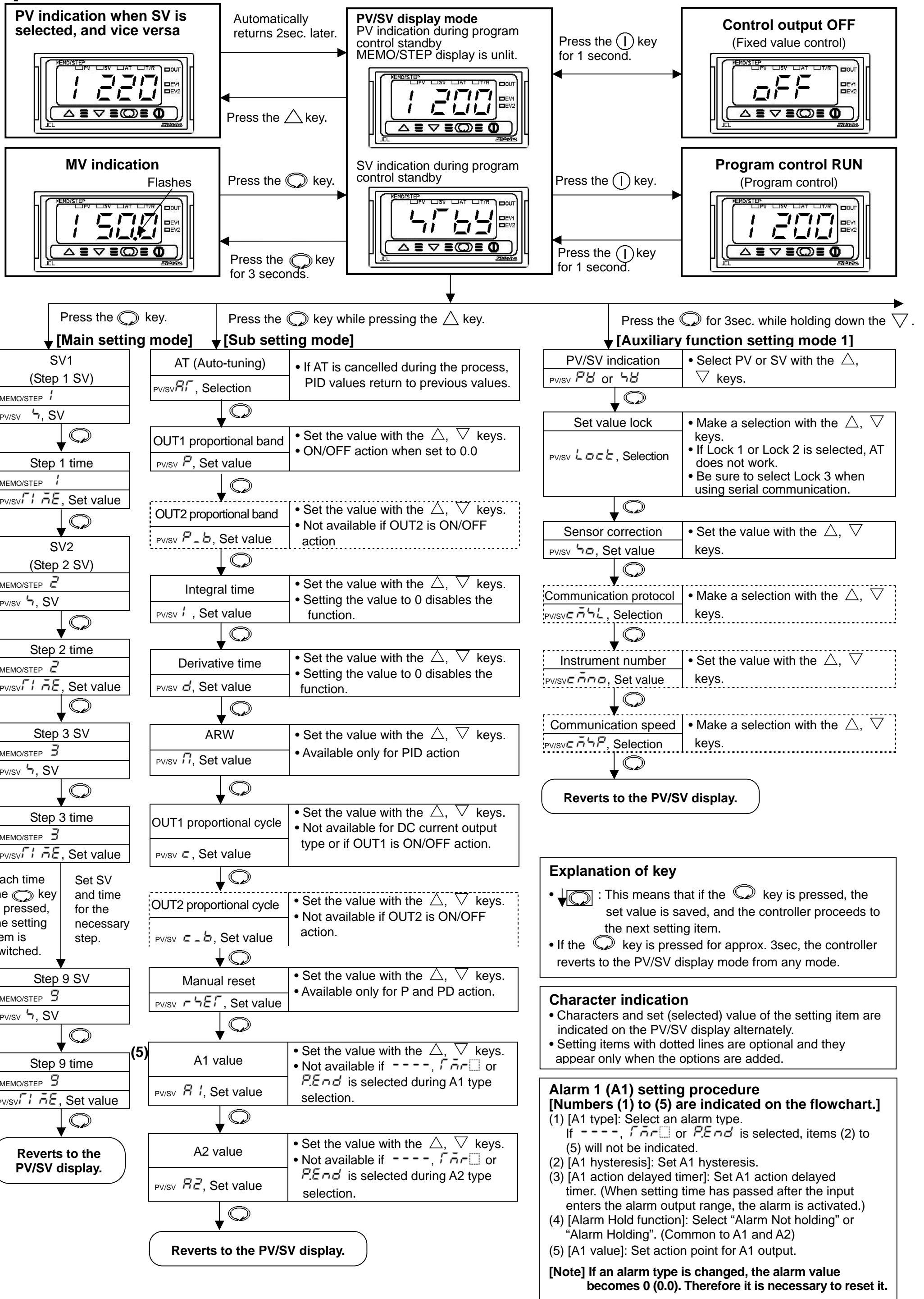

Input type (Character indication) and range					
$\text{K}$	K	-200 to 1370 °C	$\text{K}$	K	-320 to 2500 °F
$\text{L}$	L	-199.9 to 400.0 °C	$\text{L}$	L	-199.9 to 750.0 °F
$\text{J}$	J	-200 to 1000 °C	$\text{J}$	J	-320 to 1800 °F
$\text{R}$	R	0 to 1760 °C	$\text{R}$	R	0 to 3200 °F
$\text{S}$	S	0 to 1760 °C	$\text{S}$	S	0 to 3200 °F
$\text{B}$	B	0 to 1820 °C	$\text{B}$	B	0 to 3300 °F
$\text{E}$	E	-200 to 800 °C	$\text{E}$	E	-320 to 1500 °F
$\text{T}$	T	-199.9 to 400.0 °C	$\text{T}$	T	-199.9 to 750.0 °F
$\text{N}$	N	-200 to 1300 °C	$\text{N}$	N	-320 to 2300 °F
$\text{PL-II}$	PL-II	0 to 1390 °C	$\text{PL-II}$	PL-II	0 to 2500 °F
$\text{C(W/Re5-26)}$	C(W/Re5-26)	0 to 2315 °C	$\text{C(W/Re5-26)}$	C(W/Re5-26)	0 to 4200 °F
$\text{Pt100}$	Pt100	-199.9 to 850.0 °C	$\text{Pt100}$	Pt100	-199.9 to 999.9 °F
$\text{JPt100}$	JPt100	-199.9 to 500.0 °C	$\text{JPt100}$	JPt100	-199.9 to 900.0 °F
$\text{Pt100}$	Pt100	-200 to 850 °C	$\text{Pt100}$	Pt100	-300 to 1500 °F
$\text{JPt100}$	JPt100	-200 to 500 °C	$\text{JPt100}$	JPt100	-300 to 900 °F
$\text{4 to 20mA DC}$	4 to 20mA DC	-1999 to 9999	$\text{0 to 1V DC}$	0 to 1V DC	-1999 to 9999
$\text{0 to 20mA DC}$	0 to 20mA DC	-1999 to 9999	$\text{0 to 5V DC}$	0 to 5V DC	-1999 to 9999
			$\text{1 to 5V DC}$	1 to 5V DC	-1999 to 9999
			$\text{0 to 10V DC}$	0 to 10V DC	-1999 to 9999

Alarm types	
$\text{H}$	(High limit alarm): The alarm action is $\pm$ deviation setting from the SV. The alarm is activated if the input value reaches the high limit set value.
$\text{L}$	(Low limit alarm): The alarm action is $\pm$ deviation setting from the SV. The alarm is activated if the input value goes under the low limit set value.
$\text{HL}$	(High/Low limits alarm): Combines High limit and Low limit alarm actions. When input value reaches high limit set value or goes under the low limit set value, the alarm is activated.
$\text{di d}$	(High/Low limit range alarm): When input value is between the high limit set value and low limit set value, the alarm is activated.
$\text{RA}$	(Process high alarm), $\text{rRA}$ (Process low alarm): Within the scale range of the controller, alarm action points can be set at random and if the input reaches the randomly set action point, the alarm is activated.
$\text{HSD}$	(High limit alarm with standby), $\text{LSD}$ (Low limit alarm with standby)
$\text{HLSd}$	(High/Low limits alarm with standby) When the power to the controller is turned on, even if the input enters the alarm action range, the alarm is not activated. (If the controller is allowed to keep running, once the input exceeds the alarm action point, the standby function will be released.)
$\text{rnr}$	(Timer function): If external signal enters, timer counting starts, and the action selected during Delay action type selection is outputted after the set delay time has passed.
$\text{PEnd}$	(Pattern end output): When the program ends normally, pattern end output is turned ON. The output is maintained until it is released with the $\text{O}$ key.

Press  $\nabla$  key for 3sec while holding down the  $\Delta$  key.

**[Auxiliary function setting mode 2]**

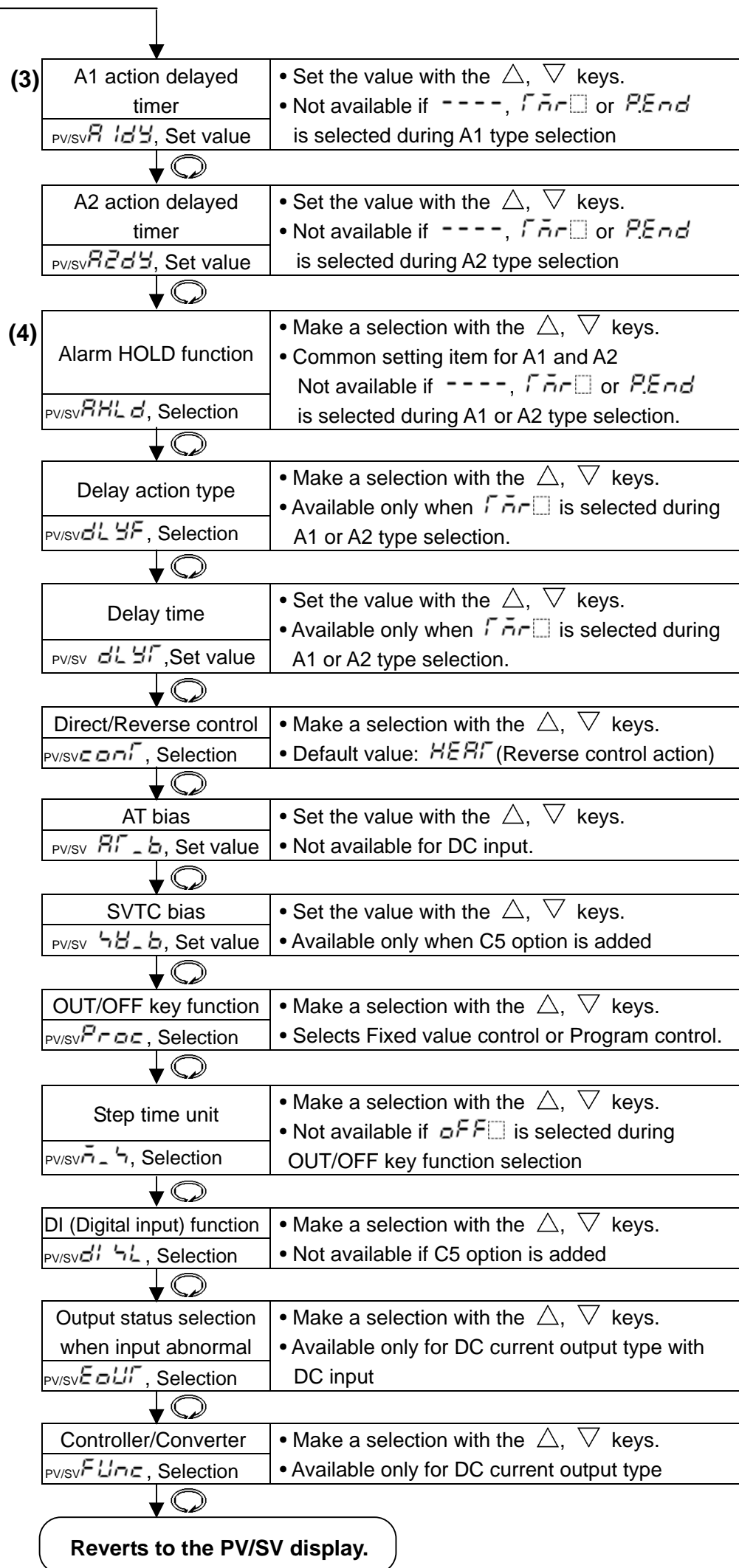
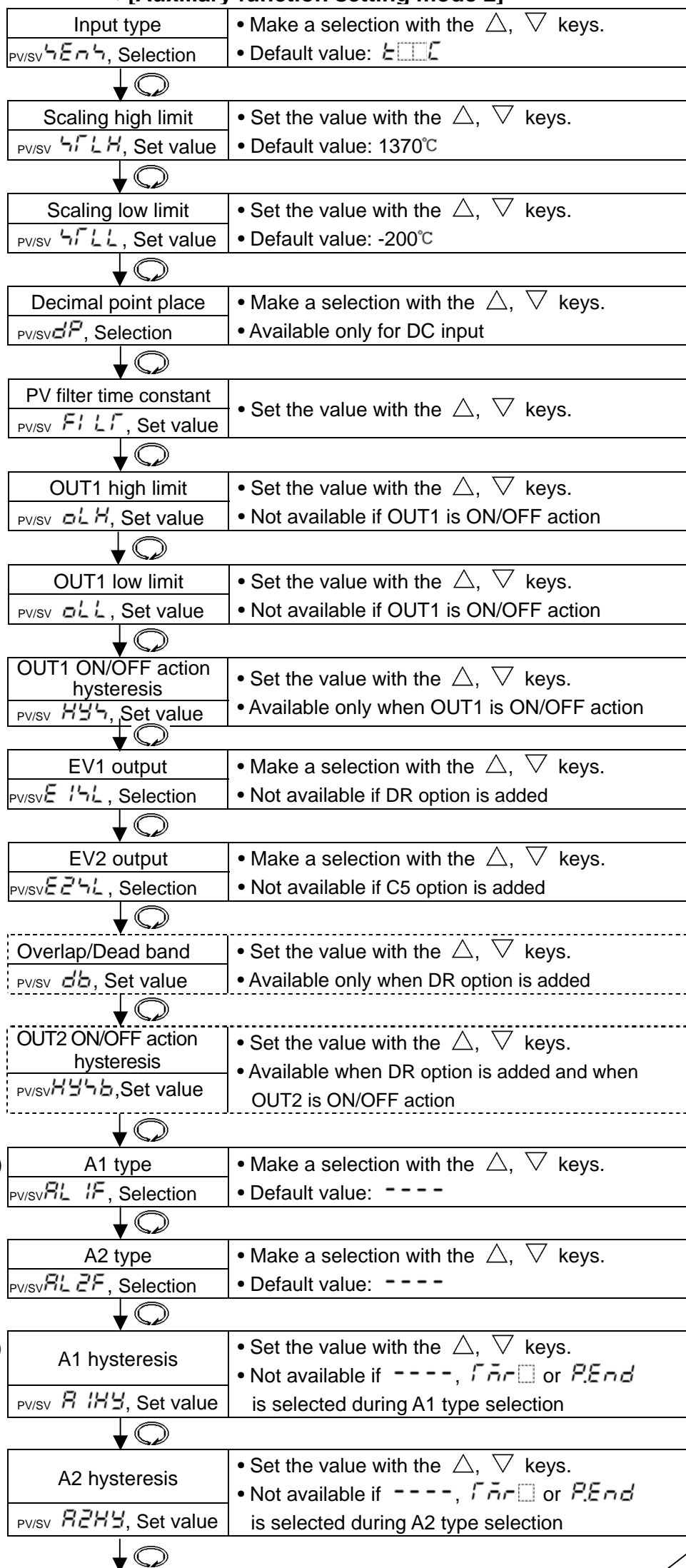

# 9. PID auto-tuning

In order to set each value of P, I, D and ARW automatically, the auto-tuning process should be made to fluctuate to obtain an optimal value. One of 3 types of fluctuation below is automatically selected.

**⚠ Notice**

- Perform auto-tuning during trial run.
- During auto-tuning, none of the setting items can be set.
- If auto-tuning starts during program control run, auto-tuning performs at SV of which auto-tuning starts. The step time does not progress until auto-tuning ends.
- If power failure occurs during auto-tuning, auto-tuning stops.
- For DC input, the AT process will fluctuate around the SV for conditions of (A), (B) and (C) below.
- **Sometimes the auto-tuning process will not fluctuate if auto-tuning is performed at or near room temperature. Therefore auto-tuning might not finish normally.**

**(A) In the case of a large difference between the SV and processing temperature as the temperature is rising**  
 When AT bias is set to 20°C, the AT process will fluctuate at the temperature 20°C lower than the SV.

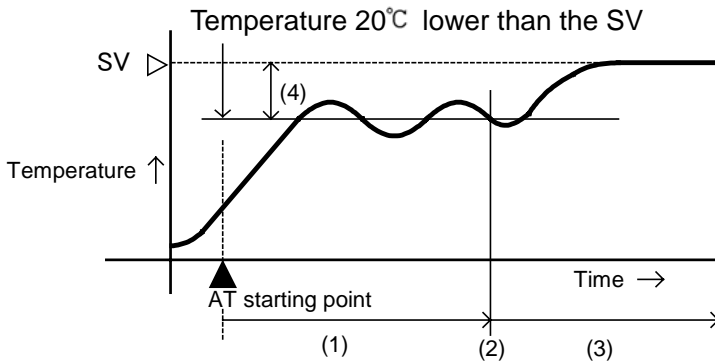

(Fig. 9-1)

- (1) Calculating PID constant
- (2) PID constant calculated
- (3) Controlled by the PID constant set by auto-tuning.
- (4) AT bias value

**(B) When the control is stable or when control temperature is within ±20°C of the SV**  
 The AT process will fluctuate around the SV.

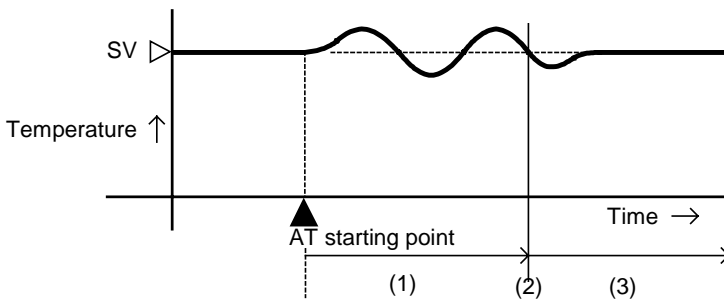

(Fig. 9-2)

- (1) Calculating PID constant
- (2) PID constant calculated
- (3) Controlled by the PID constant set by auto-tuning.

**(C) In the case of a large difference between the SV and processing temperature as the temperature is falling**  
 When AT bias is set to 20°C, the AT process will fluctuate at the temperature 20°C higher than the SV.

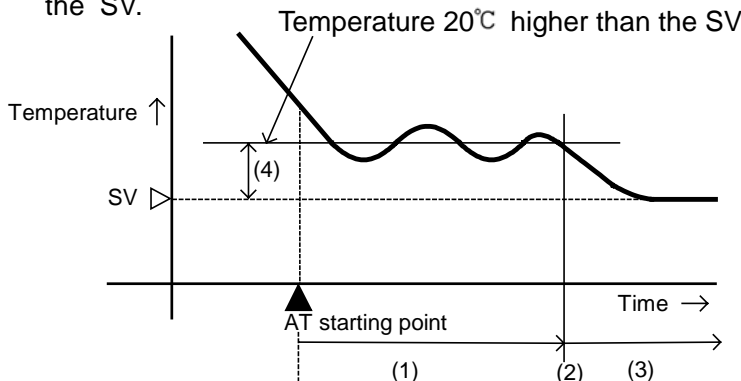

(Fig. 9-3)

- (1) Calculating PID constant
- (2) PID constant calculated
- (3) Controlled by the PID constant set by auto-tuning.
- (4) AT bias value

# 10. Action explanation

## 10.1 OUT1 action

	Heating (Reverse) action	Cooling (Direct) action
Control action		
Relay contact output	<p>Cycle action is performed according to deviation</p>	<p>Cycle action is performed according to deviation</p>
Non-contact voltage output	<p>Cycle action is performed according to deviation</p>	<p>Cycle action is performed according to deviation</p>
DC current output	<p>Changes continuously according to deviation</p>	<p>Changes continuously according to deviation</p>
Indicator (OUT) Green		

: Acts ON or OFF.

## 10.2 OUT1 ON/OFF action

	Heating (Reverse) action	Cooling (Direct) action
Control action		
Relay contact output		
Non-contact voltage output		
DC current output		
Indicator (OUT) Green		

: Acts ON or OFF.

### 10.3 A1, A2 action

	High limit alarm	Low limit alarm	High/Low limits alarm
Alarm action			
	High/Low limit range alarm	Process high alarm	Process low alarm
Alarm action			
	High limit alarm with standby	Low limit alarm with standby	High/Low limits alarm with standby
Alarm action			

: Standby functions in this section.

EV1 indicator lights when terminals 8 and 9 are connected, and goes off when they are disconnected.

EV2 indicator lights when terminals 11 and 12 are connected, and goes off when they are disconnected.

### 10.4 OUT2 (Heating/Cooling control) action (When DR option is added)

Control action			
Relay contact output (OUT)			
	Cycle action is performed according to deviation.		
Non-contact voltage output (OUT)	+ ③ 12V DC - ④	+ ③ 12/0V DC - ④	+ ③ 0V DC - ④
	Cycle action is performed according to deviation.		
DC current output (OUT)	+ ③ 20mA DC - ④	+ ③ 20 to 4mA DC - ④	+ ③ 4mA DC - ④
	Changes continuously according to deviation.		
Relay contact output (EV1)			
	Cycle action is performed according to deviation.		
Indicator (OUT) Green			
	Lit	Unlit	
Indicator (EV1) Yellow			
	Unlit	Lit	

: Acts ON (lit) or OFF (unlit).

———— : Represents Heating control action.

----- : Represents Cooling control action.



### 10.5 OUT2 (Heating/Cooling control) action (When setting dead band) (When DR option is added)

Control action			
Relay contact output (OUT)	<p>Cycle action is performed according to deviation.</p>		
Non-contact voltage output (OUT)	<p>+ ③ 12V DC    + ③ 12/0V DC    + ③ 0V DC</p> <p>- ④            - ④                    - ④</p> <p>Cycle action is performed according to deviation.</p>		
DC current output (OUT)	<p>+ ③ 20mA DC    + ③ 20 to 4mA DC    + ③ 4mA DC</p> <p>- ④                - ④                      - ④</p> <p>Changes continuously according to deviation.</p>		
Relay contact output (EV1)	<p>Cycle action is performed according to deviation.</p>		
Indicator (OUT) Green			
Indicator (EV1) Yellow			

: Acts ON (lit) or OFF (unlit).

————— : Represents Heating control action.

- - - - - : Represents Cooling control action.

### 10.6 OUT2 (Heating/Cooling control) action (When setting overlap band) (When DR option is added)

Control action			
Relay contact output (OUT)	<p>Cycle action is performed according to deviation.</p>		
Non-contact voltage output (OUT)	<p>+ ③ 12V DC    + ③ 12/0V DC    + ③ 0V DC</p> <p>- ④            - ④                    - ④</p> <p>Cycle action is performed according to deviation.</p>		
DC current output (OUT)	<p>+ ③ 20mA DC    + ③ 20 to 4mA DC    + ③ 4mA DC</p> <p>- ④                - ④                      - ④</p> <p>Changes continuously according to deviation.</p>		
Relay contact output (EV1)	<p>Cycle action is performed according to deviation.</p>		
Indicator (OUT) Green			
Indicator (EV1) Yellow			

: Acts ON (lit) or OFF (unlit).

————— : Represents Heating control action.

- - - - - : Represents Cooling control action.

### 10.7 Timer action

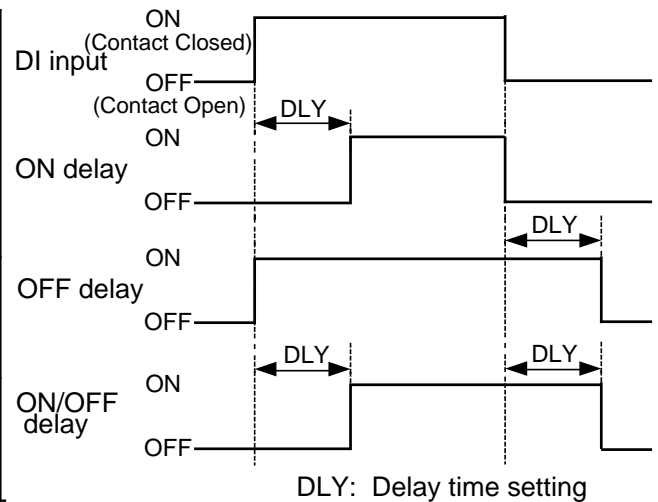

# 11. Specifications

## 11.1 Standard specifications

**Mounting** : Flush  
**Setting** : Input system using membrane sheet key  
**Display** PV/SV display: Red LED 4 digits, character size 8.7 x 5 mm (H x W)  
MEMO/STEP display: Green LED 1 digit, character size 8.7 x 5 mm (H x W)

### Accuracy (Setting and Indication):

Thermocouple : Within  $\pm 0.2\%$  of each input span  $\pm 1$  digit, or within  $\pm 2^{\circ}\text{C}$  ( $4^{\circ}\text{F}$ ), whichever is greater  
However R, S input, 0 to  $200^{\circ}\text{C}$  ( $400^{\circ}\text{F}$ ): Within  $\pm 6^{\circ}\text{C}$  ( $12^{\circ}\text{F}$ )  
B input, 0 to  $300^{\circ}\text{C}$  ( $600^{\circ}\text{F}$ ): Accuracy is not guaranteed  
K, J, E, T, N input, less than  $0^{\circ}\text{C}$  ( $32^{\circ}\text{F}$ ): Within  $\pm 0.4\%$  of input span  $\pm 1$  digit or within  $\pm 4^{\circ}\text{C}$  ( $8^{\circ}\text{F}$ ), whichever is greater

RTD : Within  $\pm 0.1\%$  of each input span  $\pm 1$  digit, or within  $\pm 1^{\circ}\text{C}$  ( $2^{\circ}\text{F}$ ), whichever is greater

DC current : Within  $\pm 0.2\%$  of each input span  $\pm 1$  digit

DC voltage : Within  $\pm 0.2\%$  of each input span  $\pm 1$  digit

**Input sampling period** : 0.25 seconds

**Input** Thermocouple : K, J, R, S, B, E, T, N, PL-II, C (W/Re5-26) External resistance,  $100\Omega$  or less  
(However, B input: External resistance,  $40\Omega$  or less)

RTD : Pt100, JPt100, 3-wire system  
Allowable input lead wire resistance ( $10\Omega$  or less per wire)

DC current : 0 to 20mA DC, 4 to 20mA DC

Input impedance: Externally connect  $50\Omega$  shunt resistor between input terminals.  
Allowable input current (50mA DC or less)

DC voltage : 0 to 1V DC Input impedance ( $1\text{M}\Omega$  or more)

Allowable input voltage (5V DC or less)

Allowable signal source resistance ( $2\text{k}\Omega$  or less)

: 0 to 5V DC, 1 to 5V DC, 0 to 10V DC Input impedance ( $100\text{k}\Omega$  or more)

Allowable input voltage (15V DC or less)

Allowable signal source resistance ( $100\Omega$  or less)

### Control output or Heating output (OUT1)

Relay contact : 1A, Control capacity 3A 250V AC (resistive load)  
1A 250V AC (inductive load  $\cos\phi=0.4$ )

Electrical life, 100,000 times

Non-contact voltage (For SSR drive): Max. 40mA  $12^{\pm 2}\text{V}$  DC (short circuit protected)

DC current : 4 to 20mA DC, Load resistance, Max.  $550\Omega$

### Event output 1 (EV1), Event output 2 (EV2)

One type can be selected from 10 types of alarm action (including No alarm action), Timer function and Pattern end output.

Alarm setting range : See (Table 6.2-1) on page 17.

Action : ON/OFF action

Hysteresis TC, RTD input :  $0.1$  to  $100.0^{\circ}\text{C}$  ( $^{\circ}\text{F}$ )  
DC current, voltage input: 1 to 1000 (The placement of the decimal point follows the selection)

A1, A2 delayed timer function: 0 to 9999 seconds

Alarm output HOLD function : Once the alarm is activated, the alarm output is maintained until the power supply to the instrument is turned OFF.

Timer function : 0 to 9999 seconds

Pattern end output : Pattern end output is turned on when the program ends normally.

EV1 output : Relay contact 1A, Control capacity, 3A 250V AC (resistive load)  
1A 250V AC (inductive load  $\cos\phi=0.4$ )

Electrical life, 100,000 times

EV2 output : Open collector, Control capacity, 0.1A (maximum) 24V DC

### Control action

PID action (with auto-tuning function)

PI action: When derivative time is set to 0

PD action (with manual reset function): When integral time is set to 0

P action (with manual reset function): When derivative and integral times are set to 0.

ON/OFF action: When proportional band is set to 0

OUT1 proportional band: 0.0 to 110.0% (ON/OFF action when set to 0.0)

Integral time : 0 to 1000s (OFF when set to 0)

Derivative time : 0 to 300s (OFF when set to 0)

OUT1 proportional cycle: 1 to 120s (Not available for DC current output type)

ARW : 0 to 100%

Manual reset :  $\pm$ Proportional band converted value

OUT1 ON/OFF action hysteresis:  $0.1$  to  $100.0^{\circ}\text{C}$  ( $^{\circ}\text{F}$ ), or 1 to 1000

OUT1 output limit : 0 to 100% (DC current output type:  $-5$  to 105%)

## DI (Digital input)

DI (Digital input) has 3 functions.

- SV1/SV2 external selection function

SV1 or SV2 can be switched by external contact. However, this function is not available if Program control function is selected during OUT/OFF key function selection.

DI terminals between 10 and 12 Open: SV1

DI terminals between 10 and 12 Closed: SV2

- OUT/OFF (RUN/STOP) external selection function

Control output OUT/OFF (Fixed value control) or Program control RUN/STOP can be switched.

[Fixed value control]

DI terminals between 10 and 12 Open: OUT (Control allowed)

DI terminals between 10 and 12 Closed: OFF (Control prohibited)

[Program control]

Program control RUN/STOP can be switched by external contact pulse input (ON time, approx. 30ms).

If pulse input enters during program control standby, program control starts.

If pulse input enters during program control run, program control stops and the controller reverts to the program control standby mode.

If pulse input enters while pattern end output is turned ON after program control ended, pattern end output is turned off. Circuit current when closed: 6mA

- Timer function

Timer counting starts by the external contact, and after the set delay time has passed, the selected event output is turned on.

## Program control function

If program control function is selected during OUT/OFF key function selection, 1 pattern 9 steps program control can be performed.

To start program control, press the  $\text{\textcircled{1}}$  key during program control standby.

(To stop the program control, press the  $\text{\textcircled{1}}$  key for approx. 1 second again.)

Progressing time error: Within  $\pm 1$  minute

Pattern end output: Pattern end output can be selected by keypad.

## Converter function

If Converter function is selected during Controller/Converter function selection, the following control parameters are automatically set, and the controller can be used as a converter. (However, available only for DC current output type)

Input/output response is approx. 1 second.

SV1 (main set value): Scaling low limit value, Integral time: 0, Derivative time: 0,

OUT1 proportional band: 100.0%, Manual reset: 0.0, A1 value: 0, A2 value: 0, Direct/Reverse action: Direct action

## Attached functions

**[Set value lock]** Locks set values to prevent setting errors.

**[Sensor correction]** The PV is corrected when the temperatures in the controlled location differs from those of the sensor location.

**[PV filter]** Reduces the effect of noise by putting first order lag filter in the PV.

**[Power failure countermeasure]** The setting data is backed up in the non-volatile IC memory.

**[Self-diagnosis]** The CPU is monitored by a watchdog timer, and when an abnormal status is found on the CPU, the controller is switched to warm-up status.

### **[Automatic cold junction temperature compensation] (Only thermocouple input type)**

This detects the temperature at the connecting terminal between the thermocouple and the instrument, and always maintains it the same status as when the reference junction is located at 0°C (32°F).

### **[Burnout]**

When the thermocouple or RTD input is burnt out, OUT1 and EV1 (DR\_option) are turned off [for DC current output type, OUT1 low limit value] and PV/SV display flashes "-----".

### **[Input abnormality indication]**

		Controller/Converter function selection			
		Controller			
		Output status			
Output status selection when input abnormal	Contents, Indication	OUT1		OUT2	
		Direct action	Reverse action	Direct action	Reverse action
$on\text{\textcircled{1}}$	Overscale Measured value has exceeded Indication range high limit value. "-----" flashes.	(*) ON (20mA) or OUT1 high limit value	OFF(4mA) or OUT1 low limit value	OFF	(*) ON
$oFF\text{\textcircled{1}}$		OFF (4mA) or OUT1 low limit value			OFF
$on\text{\textcircled{1}}$	Underscale Measured value has dropped below Indication range low limit value. "-----" flashes.	OFF (4mA) or OUT1 low limit value	(*) ON(20mA) or OUT1 high limit value	(*) ON	OFF
$oFF\text{\textcircled{1}}$			OFF(4mA) or OUT1 low limit value		

Only for DC input and DC current output type, [Output status selection when input abnormal] is usable.

(\*) Outputs a value between OFF (4mA) and ON (20mA) or between OUT1 (or OUT2) low limit value and OUT1 (or OUT2) high limit value, depending on deviation.

Contents, Indication	Controller/Converter function selection	
	Converter	
	Output status	
	OUT1	
	Direct action	Reverse action
Overscale Measured value has exceeded Indication range high limit value. "----" flashes.	ON (20mA) or OUT1 high limit value	OFF (4mA) or OUT1 low limit value
Underscale Measured value has dropped below Indication range low limit value. "----" flashes.	OFF (4mA) or OUT1 low limit value	ON (20mA) or OUT1 high limit value

### Thermocouple and RTD input

Input	Input range	Indication range	Control range
K, T	-199.9 to 400.0°C	-199.9 to 450.0°C	-205.0 to 450.0°C
	-199.9 to 750.0°F	-199.9 to 850.0°F	-209.0 to 850.0°F
Pt100	-199.9 to 850.0°C	-199.9 to 900.0°C	-210.0 to 900.0°C
	-200 to 850°C	-210 to 900°C	-210 to 900°C
	-199.9 to 999.9°F	-199.9 to 999.9°F	-211.0 to 1099.9°F
	-300 to 1500°F	-318 to 1600°F	-318 to 1600°F
JPt100	-199.9 to 500.0°C	-199.9 to 550.0°C	-206.0 to 550.0°C
	-200 to 500°C	-207 to 550°C	-207 to 550°C
	-199.9 to 900.0°F	-199.9 to 999.9°F	-211.0 to 999.9°F
	-300 to 900°F	-312 to 1000°F	-312 to 1000°F

Indication range and Control range for thermocouple inputs other than the above:

Input range low limit value -50°C (100°F) to Input range high limit value +50°C (100°F)

### DC input

Indication range: Scaling low limit value-Scaling span x 1% to Scaling high limit value- Scaling span x 10%  
However, "----" or "----" flashes when the range of -1999 to 9999 is exceeded.

Control range: Scaling low limit value-Scaling span x 1% to Scaling high limit value- Scaling span x 10%

**DC input disconnection:** When DC input is disconnected, PV/SV display flashes "----" for 4 to 20mA DC and 1 to 5V DC inputs, and "----" for 0 to 1V DC input. For 0 to 20mA DC, 0 to 5V DC and 0 to 10V DC inputs, the PV/SV display indicates the value corresponding with 0mA or 0V input.

### [Warm-up indication]

After the power supply to the instrument is turned on, the sensor input characters and temperature unit are indicated on the PV/SV display for approx. 3 seconds.

### [Temporary PV/SV indication]

If the Increase key is pressed during the PV/SV display mode, the opposite value to the value selected during PV/SV indication selection is indicated while the key is being pressed.

### Circuit insulation configuration

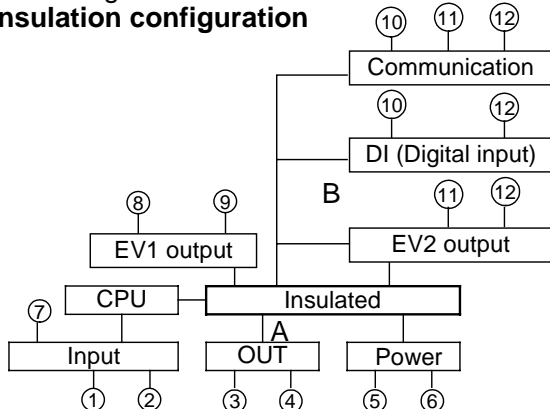

When OUT1 is non-contact voltage output or DC current output, A is not insulated from B.

A: Terminals 3, 4

B: Terminals 10, 11, 12

**Insulation resistance** : 10MΩ or more, at 500V DC

**Dielectric strength** : 1.5kV AC for 1minute between input terminal and power terminal  
1.5kV AC for 1minute between output terminal and power terminal

**Supply voltage** : 100 to 240V AC 50/60Hz, 24V AC/DC 50/60Hz

**Allowable voltage fluctuation:** 100 to 240V AC: 85 to 264V AC, 24V AC/DC: 20 to 28V AC/DC

**Power consumption** : Approx. 5VA

**Ambient temperature** : 0 to 50°C (32 to 122°F)

**Ambient humidity** : 35 to 85%RH (no condensation)

**Weight** : Approx. 120g  
**External dimension** : 48 x 24 x 98.5mm (W x H x D)  
**Material** : Flame-resistant resin (Case)  
**Color** : Light gray (Case)  
**Accessories included** : Instruction manual 1 copy, Mounting frame 1 piece  
 Terminal cover 1 piece (when TC option is applied)  
**Accessories sold separately**: Shunt resistor 1 piece (50Ω)

## 11.2 Optional specifications

### Heating/Cooling control (OUT2) (Option code: DR)

OUT2 proportional band: 0.0 to 10.0 times OUT1 proportional band (ON/OFF action when set to 0.0)  
 Integral time and derivative time are the same as those of OUT1 action.  
 OUT2 proportional cycle: 1 to 120 seconds  
 Overlap band/Dead band setting range  
 TC, RTD input: -100.0 to 100.0°C (°F)  
 DC input: -1000 to 1000 (The placement of the decimal point follows the selection)  
 OUT2 ON/OFF action hysteresis setting  
 TC, RTD input: 0.1 to 100.0°C (°F)  
 DC input: 1 to 1000 (The placement of the decimal point follows the selection)  
 Output: Relay contact 1a, Control capacity 3A 250V AC (resistive load),  
 1A 250V AC (inductive load  $\cos\phi=0.4$ )

### Serial communication (Option code: C5)

The following operations can be carried out from the external computer.

- (1) Reading and setting of SV, PID values and each set value
  - (2) Reading of the input value and action status
  - (3) Change of the functions
- Cable length : Maximum 1.2km, Cable resistance, Within 50Ω  
 Communication line : EIA RS-485  
 Communication method : Half-duplex communication  
 Communication speed : 2400, 4800, 9600, 19200bps (Can be selected by keypad)  
 Synchronization : Start-stop synchronization  
 Parity : Even (When IMO protocol or Modbus ASCII is selected),  
 No parity (When Modbus RTU is selected)  
 Stop bit : 1  
 Communication protocol : IMO protocol, Modbus RTU, Modbus ASCII (Can be selected by keypad)  
 Number of connectable units : Maximum 31 units to 1 host computer  
 Communication error detection: Parity, checksum (LRC), CRC

**Color Black (Option code: BK)** Front panel frame and case: Black

**Terminal cover (Option code: TC)** Electrical shock protection terminal cover

## 12. Troubleshooting

If any malfunctions occur, refer to the following items after checking the power supply to the controller.

### 12.1 Indication

Problem	Presumed cause and solution
[OFF] is indicated on the PV/SV display.	<ul style="list-style-type: none"> <li>Control output OFF function is working. To release the function, press the ① key for approx. 1 second.</li> </ul>
[LbL] is indicated on the PV/SV display.	<ul style="list-style-type: none"> <li>This is program standby status. If Program control function is selected during OUT/OFF key function selection and if SV is selected during PV/SV indication selection, "LbL" is indicated during program standby. If PV is selected during PV/SV indication selection, the PV is indicated.</li> </ul>
[----] is flashing on the PV/SV display.	<ul style="list-style-type: none"> <li>Burnout of Thermocouple, RTD or disconnection of DC voltage (0 to 1V DC): Change each sensor.  <b>How to check whether the sensor is burnt out</b>            [Thermocouple]            If the input terminals of the instrument are shorted, and if a value around room temperature is indicated, the instrument is likely to be operating normally, however, the sensor may be burnt out.            [RTD]            If approx. 100Ω of resistance is connected to the input terminals between A-B of the instrument and between B-B is shorted, and if approximate 0°C (32°F) is indicated, the instrument is likely to be operating normally, however, the sensor may be burnt out.            [DC voltage (0 to 1V DC)]            If the input terminals of the instrument are shorted, and if a scaling low limit value is indicated, the instrument is likely to be operating normally, however, the signal wire may be disconnected.</li> </ul>

	<ul style="list-style-type: none"> <li>• Check whether the input terminals of thermocouple, RTD or DC voltage (0 to 1V DC) are securely mounted to the instrument input terminals. Connect the sensor terminals to the instrument input terminals securely.</li> </ul>
[ - - - ] is flashing on the PV/SV display.	<ul style="list-style-type: none"> <li>• Check whether input signal source for DC voltage (1 to 5V DC) or DC current (4 to 20mA DC) is disconnected. <b>How to check whether the input signal wire is disconnected</b> [DC voltage (1 to 5V DC)] If the input to the input terminals of the instrument is 1V DC and if a scaling low limit value is indicated, the instrument is likely to be operating normally, however, the signal wire may be disconnected.</li> <li>• [DC current (4 to 20mA DC)] If the input to the input terminals of the instrument is 4mA DC and if a scaling low limit value is indicated, the instrument is likely to be operating normally, however, the signal wire may be disconnected.</li> <li>• Check whether input signal wire for DC voltage (1 to 5V DC) or DC current (4 to 20mA DC) is securely connected to the instrument input terminals.</li> <li>• Check if polarity of thermocouple or compensating lead wire is correct.</li> <li>• Check whether codes (A, B, B) of RTD agree with the instrument terminals.</li> </ul>
The PV/SV display keeps indicating the value which was set during Scaling low limit setting.	<ul style="list-style-type: none"> <li>• Check whether the input signal source for DC voltage (0 to 5V DC, 0 to 10V DC) and DC current (0 to 20mA DC) is disconnected. <b>How to check whether the input signal wire is disconnected</b> [DC voltage (0 to 5V DC, 0 to 10V DC)] If the input to the input terminals of the instrument is 1V DC and if the value corresponding to 1V DC is indicated, the instrument is likely to be operating normally, however, the signal wire may be disconnected.</li> <li>• [DC current (0 to 20mA DC)] If the input to the input terminals of the instrument is 1mA DC and if the value corresponding to 1mA DC is indicated, the instrument is likely to be operating normally, however, the signal wire may be disconnected.</li> <li>• Check whether the input lead wire terminals for DC voltage (0 to 5V DC, 0 to 10V DC) or DC current (0 to 20mA DC) are securely mounted to the instrument input terminals.</li> </ul>
The indication of the PV/SV display is abnormal or unstable.	<ul style="list-style-type: none"> <li>• Check whether sensor input or temperature unit (°C or °F) is correct. Select the sensor input and temperature unit (°C or °F) properly.</li> <li>• Sensor correcting value is unsuitable. Set it to a suitable value.</li> <li>• AC leaks into the sensor circuit. Use an ungrounded type sensor.</li> <li>• There may be equipment that interferes with or makes noise near the controller. Keep equipment that interferes with or makes noise away from the controller.</li> </ul>
[Err !] is indicated on the PV/SV display.	<ul style="list-style-type: none"> <li>• Internal memory is defective. Contact our agency or us.</li> </ul>

## 12.2 Key operation

Problem	Presumed cause and solution
<ul style="list-style-type: none"> <li>• Unable to set the SV1, P, I, D, proportional cycle or alarm.</li> <li>• The values do not change by the <math>\Delta</math>, <math>\nabla</math> keys.</li> </ul>	<ul style="list-style-type: none"> <li>• Set value lock (Lock 1 or Lock 2) is designated. Release the lock designation.</li> <li>• Auto-tuning is performing. In the case of auto-tuning, cancel auto-tuning.</li> <li>• No alarm action, Timer function or Pattern end output has been selected during A1, A2 alarm type selection. Select an alarm type after checking the selected value.</li> </ul>
SV2 cannot be set.	<ul style="list-style-type: none"> <li>• SV1/SV2 external selection function has not been selected during DI (Digital input) function selection. Select SV1/SV2 external selection function after checking the selected value. Not available if C5 option is applied.</li> </ul>
The setting indication does not change within the input range even if the $\Delta$ , $\nabla$ keys are pressed, and new values are unable to be set.	<ul style="list-style-type: none"> <li>• Scaling high or low limit value in Auxiliary function setting mode 2 may be set at the point where the value does not change. Set it to a suitable value while in Auxiliary function setting mode 2.</li> </ul>

### 12.3 Control

Problem	Presumed cause and solution
Temperature does not rise.	<ul style="list-style-type: none"> <li>• Sensor is out of order. Replace the sensor.</li> <li>• Check whether the sensor or actuator is securely mounted to the input or output terminals of the instrument. Ensure that the sensor or actuator is mounted to the instrument input or output terminals securely.</li> <li>• Check whether the wiring of sensor or actuator is correct.</li> </ul>
The control output remains ON status.	<ul style="list-style-type: none"> <li>• OUT1 low limit value in Auxiliary function setting mode 2 is set to 100% or higher. Set it to a suitable value.</li> </ul>
The control output remains OFF status.	<ul style="list-style-type: none"> <li>• OUT1 high limit value in Auxiliary function setting mode 2 is set to 0% or less. Set it to a suitable value.</li> </ul>
Program control ends soon even if it is performed.	<ul style="list-style-type: none"> <li>• Step time has been set to 00:00. Set the step time.</li> </ul>
Timer does not work.	<ul style="list-style-type: none"> <li>• Check whether the Delay action type or Delay time is set properly. Set or select the value properly.</li> <li>• Check whether the Timer function is selected during DI (Digital input) function selection. Select Timer function after checking. If C5 option is applied, DI (Digital input) function selection item is not available.</li> </ul>

For all other malfunctions, please contact our main office or dealers.

## 13. Character table

Photocopiable material

[Main setting mode]

Indication	Setting item	Default value	Data
14.00	SV1 (step 1 SV)	0°C	
101 AE	Step 1 time	00:00	
24.00	SV2 (step 2 SV)	0°C	
201 AE	Step 2 time	00:00	
34.00	Step 3 SV	0°C	
301 AE	Step 3 time	00:00	
44.00	Step 4 SV	0°C	
401 AE	Step 4 time	00:00	
54.00	Step 5 SV	0°C	
501 AE	Step 5 time	00:00	
64.00	Step 6 SV	0°C	
601 AE	Step 6 time	00:00	
74.00	Step 7 SV	0°C	
701 AE	Step 7 time	00:00	
84.00	Step 8 SV	0°C	
801 AE	Step 8 time	00:00	
94.00	Step 9 SV	0°C	
901 AE	Step 9 time	00:00	

[Sub setting mode]

Indication	Setting item	Default value	Data
AT	AT (Auto-tuning)	Cancel	
P	OUT1 proportional band	2.5%	
P_b	OUT2 proportional band	1.0 times	
I	Integral time	200sec	
d	Derivative time	50sec	
ARW	ARW	50%	
c	OUT1 proportional cycle	Relay contact: 30sec Non-contact: 3sec DC current: Unavailable	
c_b	OUT2 proportional cycle	30sec	
r4Er	Manual reset	0.0°C	
A1	A1 value	0°C	
A2	A2 value	0°C	

**[Auxiliary function setting mode 1]**

Indication	Setting item	Default value	Data
<input type="checkbox"/> PV	PV/SV indication	PV indication	
<input type="checkbox"/> Lock	Set value lock	Unlock	
<input type="checkbox"/> Co	Sensor correction	0.0°C	
<input type="checkbox"/> c24	Communication protocol	IMO protocol	
<input type="checkbox"/> c000	Instrument number	0	
<input type="checkbox"/> c24P	Communication speed	9600bps	

**[Auxiliary function setting mode 2]**

Indication	Setting item	Default value	Data
<input type="checkbox"/> 4En4	Input type	K: -200 to 1370°C	
<input type="checkbox"/> 4FLH	Scaling high limit value	1370°C	
<input type="checkbox"/> 4FLl	Scaling low limit value	-200°C	
<input type="checkbox"/> dP	Decimal point place	No decimal point	
<input type="checkbox"/> FILT	PV filter time constant	0.0sec	
<input type="checkbox"/> oLH	OUT1 high limit	100%	
<input type="checkbox"/> oLL	OUT1 low limit	0%	
<input type="checkbox"/> HY4	OUT1 ON/OFF action hysteresis	1.0°C	
<input type="checkbox"/> E14	EV1 output	A1 output	
<input type="checkbox"/> E24	EV2 output	A2 output	
<input type="checkbox"/> db	Overlap band/Dead band	0.0°C	
<input type="checkbox"/> HY4b	OUT2 ON/OFF action hysteresis	1.0°C	
<input type="checkbox"/> AL1F	Alarm 1 (A1) type	No alarm action	
<input type="checkbox"/> AL2F	Alarm 2 (A2) type	No alarm action	
<input type="checkbox"/> A1HY	Alarm 1 (A1) hysteresis	1.0°C	
<input type="checkbox"/> A2HY	Alarm 2 (A2) hysteresis	1.0°C	
<input type="checkbox"/> A1dy	A1 action delayed timer	0 seconds	
<input type="checkbox"/> A2dy	A2 action delayed timer	0 seconds	
<input type="checkbox"/> AHLd	Alarm HOLD function	Alarm Not holding	
<input type="checkbox"/> dLYF	Delay action type	ON delay	
<input type="checkbox"/> dLYT	Delay time	0 seconds	
<input type="checkbox"/> c00f	Direct (Cooling)/Reverse (Heating) action	Reverse (Heating)	
<input type="checkbox"/> AT_b	AT bias	20°C	
<input type="checkbox"/> 48_b	SVTC bias	0°C	
<input type="checkbox"/> Proc	OUT/OFF key function	Control output OUT/OFF	
<input type="checkbox"/> n_4	Step time unit	Hour:Minute	
<input type="checkbox"/> di_4L	DI (Digital input) function	SV1/SV2 external selection	
<input type="checkbox"/> EoUf	Output status selection when input abnormal	Output OFF	
<input type="checkbox"/> Func	Controller/Converter function	Controller function	

**IMO PRECISION CONTROLS LTD.**

WWW.IMOPC.COM